

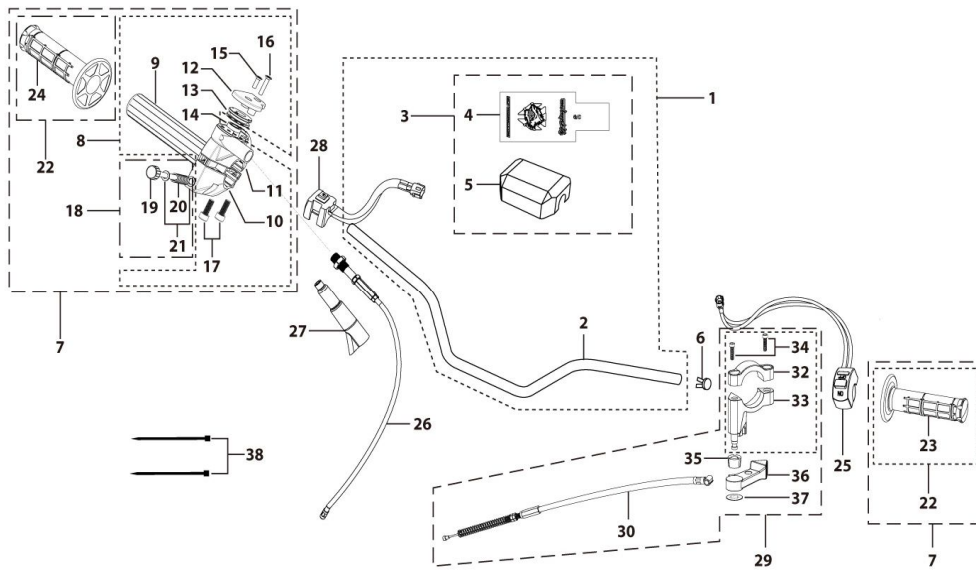

BIKE CODE FOR ORDERS	26-50A-STD	BIKE DESCRIPTION NAME	YCF 50A 2026	CONTROL STATUS
EFFECTED DATE(D/M/Y)	22/1/2026	VERSION	2026A0	



Handle bar assembly



N°	Ref.	Description	Français	Picture	Qty/ Bike	MY
2	YC50-0101-03-BK	YCF50 Handle Bar chromoly L=580mm d=22.2mm d=19mm no cross bar,with cross bar, embossed Black	YCF50 Guidon Chromolly L=580mm d=22.2mm d=19mm avec barre, stries, Noir		1	
2	GASB50-BL	YCF50 Aluminium Handle Bar (with black pad and pvc) BLUE	guidon alu complet YCF50 avec mousse et pvc BLEU		1	AFTERMAR KET
2	GASB50-BK	YCF50 Aluminium Handle Bar (with black pad and pvc) BLACK	guidon alu complet YCF50 avec mousse et pvc NOIR		1	AFTERMAR KET
2	GASB50-GR	YCF50 Aluminium Handle Bar (with black pad and pvc) GREEN	guidon alu complet YCF50 avec mousse et pvc VERT		1	AFTERMAR KET
2	GASB50-RD	YCF50 Aluminium Handle Bar (with black pad and pvc) RED	guidon alu complet YCF50 avec mousse et pvc ROUGE		1	AFTERMAR KET









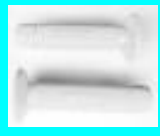

BIKE CODE FOR ORDERS		26-50A-STD	BIKE DESCRIPTION NAME	YCF 50A 2026	CONTROL STATUS	
EFFECTED DATE(D/M/Y)		22/1/2026	VERSION	2026A0		
2	GASB50-OR	YCF50 Aluminium Handle Bar (with black pad and pvc) ORANGE	guidon alu complet YCF50 avec mousse et pvc ORANGE		1	AFTERMARKET
3	YC50-0131-01	Complete Bar Pad for Handlebar without Bar L=126mm YCF50 Black-WHITE	Mousse guidon complete pour guidon Aluminium sans Barre YCF50 L=126mm Noir-BLANC		1	
3	YC50-0129-BK	YCF Bar pad L=126mm 50cc 2013 BLACK	mousse guidon complete L=126mm YCF 50cc 2013 NOIR		1	AFTERMARKET
3	YC50-0129-BL	YCF Bar pad L=126mm 50cc 2013 BLUE	mousse guidon complete L=126mm YCF 50cc 2013 BLEU		1	AFTERMARKET
3	YC50-0129-GR	YCF Bar pad L=126mm 50cc 2013 GREEN	mousse guidon complete L=126mm YCF 50cc 2013 VERT		1	AFTERMARKET
3	YC50-0129-OR	YCF Bar pad L=126mm 50cc 2013 ORANGE	mousse guidon complete L=126mm YCF 50cc 2013 ORANGE		1	AFTERMARKET
3	YC50-0129-YE	YCF Bar pad L=126mm 50cc 2013 YELLOW	mousse guidon complete L=126mm YCF 50cc 2013 JAUNE		1	AFTERMARKET
3	YC50-0129-PK	YCF Bar pad L=126mm 50cc 2013 PINK	mousse guidon complete L=126mm YCF 50cc 2013 ROSE		1	AFTERMARKET
3	YC50-0129-RD	YCF Bar pad L=126mm 50cc 2013 RED	mousse guidon complete L=126mm YCF 50cc 2013 ROUGE		1	AFTERMARKET
3	YC50-0129-WH	YCF Bar pad L=126mm 50cc 2013 WHITE	mousse guidon complete L=126mm YCF 50cc 2013 BLANC		1	AFTERMARKET
6	YC110-0153-01	Handle bar plastic cap,Nylon,Black	Embout plastique de guidon,nylon,Noir		1	
7	YC110-0138-10-BK	Complete Throttle Assy. (With adjusting bolts)+set of grip (YCF LOGO) BLACK d=19mm, 2026	Poignee gaz réglable complete YCF avec Paire de poignée caoutchouc YCF NOIR d=19mm 2026 + vis réglage		1	
7	YC110-0138-04	Complete Throttle Assy. (With adjusting bolts)+set of grip (YCF LOGO) Grey 2020	Poignee gaz réglable complete YCF 2020 avec Paire de poignée caoutchouc YCF GRIS 2020 + vis réglage		1	AFTERMARKET
15	GB819-M4x14	Countersunk cross head machine screw,stainless steel, M4x14mm	Vis à tête fraisée plate cruciforme,inox, M4x14mm		1	
16	GB819-M4x20	Countersunk cross head machine screw,stainless steel, M4x20mm	Vis à tête fraisée plate cruciforme,inox, M4x20mm		1	





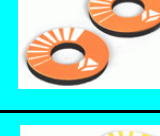
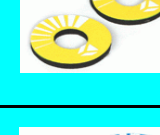







BIKE CODE FOR ORDERS		26-50A-STD	BIKE DESCRIPTION NAME	YCF 50A 2026	CONTROL STATUS	
EFFECTED DATE(D/M/Y)		22/1/2026	VERSION	2026A0		
17	GB70-M6x25	HEXAGON SOCKET Head Bolt, stainless steel, M6x25mm	Vis Allen (BTR)inox, M6x25mm		2	
18	YC110-01022-06	Complete SCREW FOR THROTTLE ADJUSTMENT,(with GB97-d5xd9x1-W2A + YC110-01021-06 1EA+YC110-01021-07 1EA)	VIS M5X50 POUR RÉGLAGE DE LA POIGNÉE DE GAZ complete (avec GB97-d5xd9x1-W2A + YC110-01021-06 1EA+YC110-01021-07 1EA)		1	
22	BB12-PPC014-BK	Set of grip 2024 Balance Bike (YCF LOGO) Black	Paire de poignée caoutchouc 2024 petit Ø Drezienne (YCF LOGO) Noire		1	
	BB12-PPC014-PK	Set of grip 2024 Balance Bike (YCF LOGO) PINK	Paire de poignée caoutchouc 2024 petit Ø Drezienne (YCF LOGO) ROSE		1	AFTERMARKET
	BB12-PPC014-RD	Set of grip 2024 Balance Bike (YCF LOGO) RED	Paire de poignée caoutchouc 2024 petit Ø Drezienne (YCF LOGO) ROUGE		1	AFTERMARKET
	BB12-PPC014-YE	Set of grip 2024 Balance Bike (YCF LOGO) YELLOW	Paire de poignée caoutchouc 2024 petit Ø Drezienne (YCF LOGO) JAUNE		1	AFTERMARKET
	BB12-PPC014-GR	Set of grip 2024 Balance Bike (YCF LOGO) GREEN	Paire de poignée caoutchouc 2024 petit Ø Drezienne (YCF LOGO) VERT		1	AFTERMARKET
	BB12-PPC014-OR	Set of grip 2024 Balance Bike (YCF LOGO) ORANGE	Paire de poignée caoutchouc 2024 petit Ø Drezienne (YCF LOGO) ORANGE		1	AFTERMARKET
	BB12-PPC014-GY	Set of grip 2024 Balance Bike (YCF LOGO) GREY	Paire de poignée caoutchouc 2024 petit Ø Drezienne (YCF LOGO) GRIS		1	AFTERMARKET
	PPC011-GY	set of grip 2020 (YCF LOGO) Grey	Paire de poignée caoutchouc 2020 (YCF LOGO) GRISE		1	AFTERMARKET
	PPC011-PK	YCF set of grip PINK 2020款	paire de poignée caoutchouc YCF ROSE 2020款		1	AFTERMARKET
	PPC011-RD	YCF set of grip RED 2020	paire de poignée caoutchouc YCF ROUGE 2020		1	AFTERMARKET



BIKE CODE FOR ORDERS		26-50A-STD	BIKE DESCRIPTION NAME	YCF 50A 2026	CONTROL STATUS	
EFFECTED DATE(D/M/Y)		22/1/2026	VERSION	2026A0		
PPC011-BL	YCF set of grip BLUE 2020	paire de poignée caoutchouc YCF BLEU 2020		1	AFTERMARKET	
PPC011-WH	YCF set of grip WHITE 2020	paire de poignée caoutchouc YCF BLANC 2020		1	AFTERMARKET	
PPC011-YE	YCF set of grip YELLOW 2020	paire de poignée caoutchouc YCF JAUNE 2020		1	AFTERMARKET	
PPC011-GR	YCF set of grip GREEN 2020	paire de poignée caoutchouc YCF VERT 2020		1	AFTERMARKET	
PPC011-BK	YCF set of grip BLACK 2020	paire de poignée caoutchouc YCF Noir 2020		1	AFTERMARKET	
PPC011-OR	YCF set of grip ORANGE 2020	paire de poignée caoutchouc YCF ORANGE 2020		1	AFTERMARKET	
PPC011-BLY	YCF set of grip Sky blue 2020	paire de poignée caoutchouc YCF BLEU 2020		1	AFTERMARKET	
DONUTZ-02-RD	YCF DONUTS d25xd55x5mm 2PCS 2015 RED	DONUTS YCF d25xd55x5mm 2PCS 2015 ROUGE		1	AFTERMARKET	
DONUTZ-02-OR	YCF DONUTS d25xd55x5mm 2PCS 2015 ORANGE	DONUTS YCF d25xd55x5mm 2PCS 2015 ORANGE		1	AFTERMARKET	
DONUTZ-02-YE	YCF DONUTS d25xd55x5mm 2PCS 2015 YELLOW	DONUTS YCF d25xd55x5mm 2PCS 2015 JAUNE		1	AFTERMARKET	
DONUTZ-02-BL	YCF DONUTS d25xd55x5mm 2PCS 2015 BLUE	DONUTS YCF d25xd55x5mm 2PCS 2015 BLEU		1	AFTERMARKET	
DONUTZ-02-BK	YCF DONUTS d25xd55x5mm 2PCS 2015 BLACK	DONUTS YCF d25xd55x5mm 2PCS 2015 NOIR		1	AFTERMARKET	



BIKE CODE FOR ORDERS		26-50A-STD	BIKE DESCRIPTION NAME	YCF 50A 2026	CONTROL STATUS	
EFFECTED DATE(D/M/Y)		22/1/2026	VERSION	2026A0		
25	YC110-0105-15	Kill Switch ON/OFF L=580mm Waterproof	Coupe circuit on off L=580mm ETANCHE		1	
	YC110-0105-08	YCF Magnet kill switch	Coupe circuit YCF aimant		1	AFTERMARKET
26	YC50-0106-15	Throttle Cable L=580mm A+B=130mm Screw thread adjustable part 73mm	Cable gaz L=580mm A+B=130mm Section réglable de la vis 73mm		1	
27	YC110-0143-01	Rubber on trottle cable	Protection caoutchouc cable de gas		1	
28	YC110-0139-03	Electrical start switch Waterproof L=500mm	Bouton demareur ETANCHE L=500mm		1	
29	YC50-0142-01	Air door assembly L=440mm A+B=50mm YCF50A	Starter au Guidon Complet L=440mm A+B=50mm YCF50A		1	
30	YC50-0148-01	Air door wire L=440mm A+B=50mm, Adjusting screw M6mmx35mm	Cable pour Starter au Guidon L=440mm A+B=50mm		1	
31	YC50-0150-01	Starter bracket assembly YCF50A Black	Starter au Guidon (Partie plastique) YCF50A Noir		1	
34	GB70-M5x16	HEXAGON SOCKET Head Bolt, stainless steel, M5x16mm	Vis Allen (BTR)inox, M5x16mm		2	
38	YC110-01-03-BK	Cable tie, nylon, L=150mm Black	collier maintien cable, nylon, L=150mm Noir		2	
Steering stem assembly						



BIKE CODE FOR ORDERS	26-50A-STD	BIKE DESCRIPTION NAME	YCF 50A 2026	CONTROL STATUS
EFFECTED DATE(D/M/Y)	22/1/2026	VERSION	2026A0	

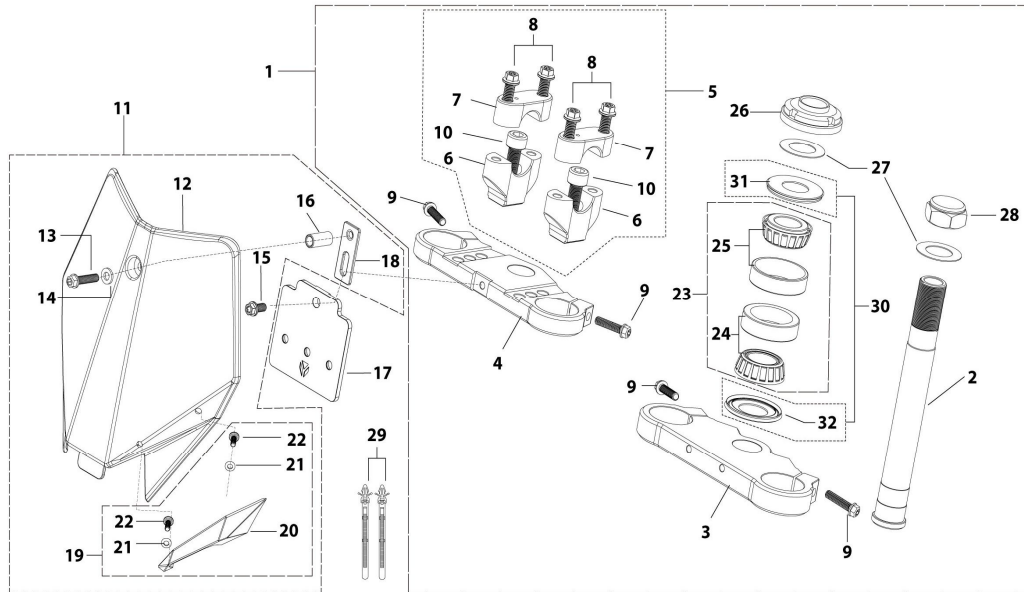









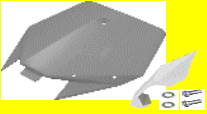

N°	Ref.	Description	Français	Picture	Qty/ Bike	MY
1	YC50-0227-04-GY	Complete Triple Clamp L=135mm Steering stem L=195mm YCF50 2024 GREY Four-hole	Te Fourche Complet L=135mm tige colonne direction L=195mm YCF50 2024 GRIS 4 trous		1	
1	YC50-0227-04-GY	Complete Triple Clamp L=135mm Steering stem L=195mm YCF50 2024 GREY Four-hole	Te Fourche Complet L=135mm tige colonne direction L=195mm YCF50 2024 GRIS 4 trous		1	AFTERMAR KET
1	YC50-0227-04-BK	Complete Triple Clamp L=135mm Steering stem L=195mm YCF50 2024 BLACK Four-hole	Te Fourche Complet L=135mm tige colonne direction L=195mm YCF50 2024 NOIR 4 trous		1	AFTERMAR KET
1	YC50-0227-04-OR	Complete Triple Clamp L=135mm Steering stem L=195mm YCF50 2024 ORANGE Four-hole	Te Fourche Complet L=135mm tige colonne direction L=195mm YCF50 2024 ORANGE 4 trous		1	AFTERMAR KET
1	YC50-0227-04-RD	Complete Triple Clamp L=135mm Steering stem L=195mm YCF50 2024 RED Four-hole	Te Fourche Complet L=135mm tige colonne direction L=195mm YCF50 2024 ROUGE 4 trous		1	AFTERMAR KET
1	YC50-0227-04-BL	Complete Triple Clamp L=135mm Steering stem L=195mm YCF50 2024 BLUE Four-hole	Te Fourche Complet L=135mm tige colonne direction L=195mm YCF50 2024 BLEU 4 trous		1	AFTERMAR KET
1	YC50-0227-04-GR	Complete Triple Clamp L=135mm Steering stem L=195mm YCF50 2024 GREEN Four-hole	Te Fourche Complet L=135mm tige colonne direction L=195mm YCF50 2024 VERT 4 trous		1	AFTERMAR KET

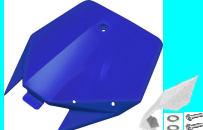













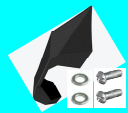

BIKE CODE FOR ORDERS		26-50A-STD	BIKE DESCRIPTION NAME	YCF 50A 2026	CONTROL STATUS	
EFFECTED DATE(D/M/Y)		22/1/2026	VERSION	2026A0		
1	YC50-0227-04-BN	Complete Triple Clamp L=135mm Steering stem L=195mm YCF50 2024 BROWN Four-hole	Te Fourche Complet L=135mm tige colonne direction L=195mm YCF50 2024 MARRON 4 trous		1	AFTERMAR KET
2	YC50-0200-02	Steering stem L=195mm	tige colonne direction L=195mm		1	
3	YC50-0202-06-GY	Lower triple clamp L=135mm d35mm H=18mm YCF50 2020 MATT GREY	té fourche inferieur L=135mm d35mm H=18mm YCF50 2020 GRIS		1	
4	YC50-0201-0601-GY	Top Triple Clamp YCF50 L=135mm d35mm H=15mm 2024 Four-hole GREY	té fourche supérieur YCF50 L=135mm d35mm H=15mm 2024 4 trous GRIS		1	
5	YC50-0228-01	Set of Bar mount not adjustable d22.2mm/H=top 18mm+bottom 36mm YCF50 2020 (with BT08- M8x25-W 4EA GB70- M10x25x1.5W 2EA) Black	Jeu pontet guidon non ajustable d22.2mm/H=supérieur 18mm+inferieur 36mm YCF50 2020 (avec BT08-M8x25-W 4EA GB70-M10x25x1.5W 2EA) Noir		1	
5	YC50-0228-0101	Set of Bar mount not adjustable d22.2mm/H=top 18mm+bottom 36mm YCF50 2020 (with BT08- M8x25-W 4EAGB70-M10x35x1.5- W 2EA YC110-0222-03 2EA) Black	Jeu pontet guidon non ajustable d22.2mm/H=supérieur 18mm+inferieur 36mm YCF50 2020 (avec BT08-M8x25-W 4EA GB70-M10x35x1.5-W 2EA YC110- 0222-03 2EA) Noir		1	AFTERMAR KET
6	YC50-0203-03	Lower Bar Mount CNC H=36mm d=22.2mm YCF50 2020 Black	Pontet guidon inférieur H=36mm d=22.2mm YCF50 2020 Noir		2	
7	YC110-0201-02	Top Bar Mout CNC d=22.2 mm H=18mm START 2020 Black	pontet guidon supérieur d=22.2mm H=18mm START 2020 Noir		2	
8	YC110-0222-03	Lower Bar Mount Heightening block CNC 22mmx22mmx12mm adjustable Black	Cale 22mmx22mmx12mm		2	AFTERMAR KET
8	BT08-M6x25-W	HEXAGON Torx screw with Flange M6x25mm	Vis HEXAGONALE Torx avec Flange M6x25mm		4	
9	BT08-M8x30-W	HEXAGON Torx screw with Flange M8x30mm	Vis HEXAGONALE Torx avec Flange M8x30mm		4	
10	GB70-M10x25x1.5-W	HEXAGON SOCKET Head Bolt,steel, M10x25mmx1.5mm	Vis Allen (BTR),acier, M10x25mmx1.5mm		2	
11	GB70-M10x35x1.5-W	HEXAGON SOCKET Head Bolt,steel, M10x35mmx1.5mm	Vis Allen (BTR),acier, M10x35mmx1.5mm		2	AFTERMAR KET







BIKE CODE FOR ORDERS		26-50A-STD	BIKE DESCRIPTION NAME	YCF 50A 2026	CONTROL STATUS	
EFFECTED DATE(D/M/Y)		22/1/2026	VERSION	2026A0		
11	YC50-0212-03-GY	YCF50 Front Number Plate 2025 Grey	Plaque avant YCF50 2025 Gris		1	
12	YC50-0212-03-YE	YCF50 Front Number Plate 2025 Yellow	Plaque avant YCF50 2025 Jaune		1	AFTERMARKET
12	YC50-0212-03-RD	YCF50 Front Number Plate 2025 Red	Plaque avant YCF50 2025 Rouge		1	AFTERMARKET
12	YC50-0212-03-OR	YCF50 Front Number Plate 2025 Orange	Plaque avant YCF50 2025 Orange		1	AFTERMARKET
12	YC50-0212-03-PK	YCF50 Front Number Plate 2025 Pink	Plaque avant YCF50 2025 Rose		1	AFTERMARKET
12	YC50-0212-03-BL	YCF50 Front Number Plate 2025 Blue	Plaque avant YCF50 2025 Bleu		1	AFTERMARKET
12	YC50-0212-03-GR	YCF50 Front Number Plate 2025 GREEN	Plaque avant YCF50 2025 VERT		1	AFTERMARKET
12	YC50-0212-03-WH	Complete Front Number Plate PP YCF50 2020 WHITE	Plaque avant Complet PP YCF50 2020 BLANC		1	AFTERMARKET
12	YC50-0212-03-BK	Complete Front Number Plate PP YCF50 2020 BLACK	Plaque avant Complet PP YCF50 2020 NOIR		1	AFTERMARKET
13	BT08-M6x30-W	HEXAGON Torx screw with Flange M6x30mm	Vis HEXAGONALE Torx avec Flange M6x30mm		1	
14	GB97-d6-W	Flat washer, steel d6mm	Rondelle plate, acier d6mm		1	
15	GBT5787-M6x16-3-W	HEXAGON screw with Flange with half thread M6x16mmx3mm	Vis HEXAGONALE avec Flange et deport M6x16mmx3mm		1	



BIKE CODE FOR ORDERS		26-50A-STD	BIKE DESCRIPTION NAME	YCF 50A 2026	CONTROL STATUS	
EFFECTED DATE(D/M/Y)		22/1/2026	VERSION	2026A0		
16	FB13-7x10x22	Front Number plate spacer (Top) d7mmxd10mmx22mm	entretoise Plaque numero avant (Haut) d7mmxd10mmx22mm		1	
17	YC110-0213-12	Front plastic plate to hold cables 75mmx80mm	Plaque avant plastique maintien cables 75mmx80mm		1	
18	YC110-0213-0401	Number plate bracket long TOP 2020	Support plaque avant 2020		1	
19	YC110-0214-01-WH	Complete Break Line Retainer (with GB818-M4x10-W 2EA+GB97- d4-W 2EA) White	guide durite avec vis sur plaque avant complet (avec GB818- M4x10-W 2EA+GB97-d4-W 2EA) Blanc		1	
20	YC110-0214-01-BK	Complete Break Line Retainer (with GB818-M4x10-W 2EA+GB97- d4-W 2EA) BLACK	guide durite avec vis sur plaque avant complet (avec GB818- M4x10-W 2EA+GB97-d4-W 2EA) NOIR		1	AFTERMAR KET
21	GB97-d4-W	Flat washer,steel d4mm	Rondelle plate,acier d4mm		2	
22	GB818-M4x10-W	Pan / Round head cross machine screw M4x10mm	Vis à tête ronde cruciforme M4x10mm		2	
23	KRDIRECTION46	set of bearing for steering 46/23.5、 46/22	Kit rlt colonne direction 46/23.5、 46/22		1	
26	YC110-02-09	Top nut for steering,steel, d=54.5mm	écrou crantellé colonne direction steel d=54.5mm		1	
27	YC110-02-10	Washer for steering stem nut, stainless steel, d22mmxd37mmx0.7mm	joint colonne direction,inox, d22mmxd37mmx0.7mm		2	
28	YC110-02-11	Nut for steering stem,steel, M22x1.0mm	écrou supérieur colnne direction ,acier, M22x1.0mm		1	
27	ECD-RD	CNC Steering stem nut M22 Red 2013	Ecrou de colonne de direction CNC Rouge		1	AFTERMAR KET
27	ECD-BL	CNC Steering stem nut M22 Blue 2013	Ecrou de colonne de direction CNC Bleu		1	AFTERMAR KET
27	ECD-BK	CNC Steering stem nut M22 Black 2013	Ecrou de colonne de direction CNC Noir		1	AFTERMAR KET
27	ECD-OR	CNC Steering stem nut M22 Orange 2013	Ecrou de colonne de direction CNC Orange		1	AFTERMAR KET



BIKE CODE FOR ORDERS		26-50A-STD	BIKE DESCRIPTION NAME	YCF 50A 2026	CONTROL STATUS	
EFFECTED DATE(D/M/Y)		22/1/2026	VERSION	2026A0		
27	ECD-GR	CNC Steering stem nut M22 GREEN 2013	Ecrou de colonne de direction CNC VERT 2013		1	AFTERMARKET
27	ECD-PU	CNC Steering stem nut M22 PURPLE 2013	Ecrou de colonne de direction CNC PURPLE 2013		1	AFTERMARKET
29	YC110-01-08-BK	Cable tie, PA66 L=80mm ADJUSTABLE Black	Collier maintien cable,PA66 L=80mm ADJUSTABLE Noir		2	
30	YC110-02-20	Washer for steering stem nut d22mm (top)/d24mm (bottom)-d47mm	Joint pour colonne direction d22mm (haut)/d24mm (bas) - d47mm		1	
	COMPT01-H	hour meter YCF 2015 BLACK	compteur heure YCF 2015 NOIR		1	AFTERMARKET
	COMPT02-H	hour meter YCF 2024	compteur heure YCF 2024		1	AFTERMARKET
	STANDCOMPT-H	Kit Stand hour meter Combination(with YC110-02-10 1EA +YC110-01-03 2EA)	Kit Plaque support compte heure		1	AFTERMARKET

Front Fender

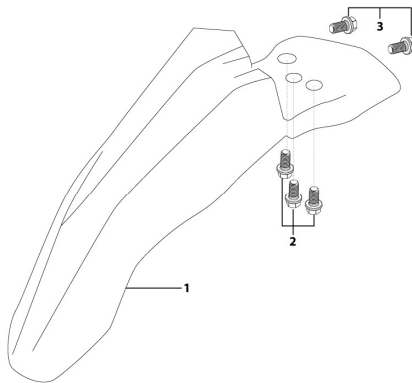



N°	Ref.	Description	Français	Picture	Qty/ Bike	MY
1	YC50-031-01-GY	Front Fender YCF50 2020 Grey	Gb avant YCF50 2020 Gris		1	
1	YC50-031-01-YE	Front Fender YCF50 2020 Yellow	Gb avant YCF50 2020 JAUNE		1	AFTERMARKET
1	YC50-031-01-RD	Front Fender YCF50 2020 Red	Gb avant YCF50 2020 Rouge		1	AFTERMARKET

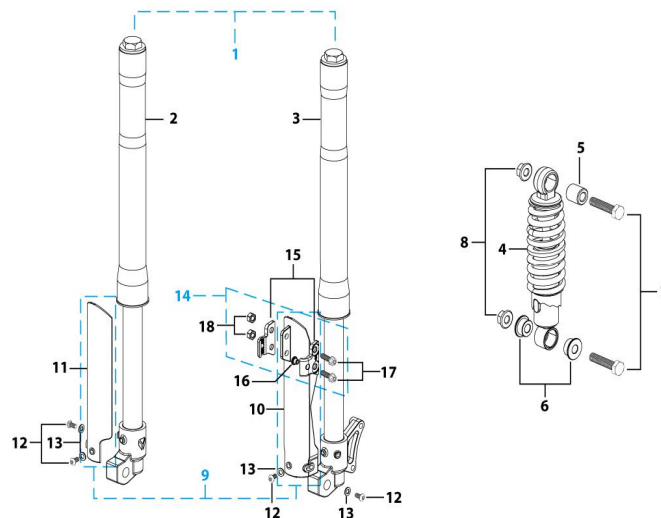

BIKE CODE FOR ORDERS		26-50A-STD	BIKE DESCRIPTION NAME	YCF 50A 2026	CONTROL STATUS	
EFFECTED DATE(D/M/Y)		22/1/2026	VERSION	2026A0		
1	YC50-031-01-OR	Front Fender YCF50 2020 Orange	Gb avant YCF50 2020 Orange		1	AFTERMARKET
1	YC50-031-01-PK	Front Fender YCF50 2020 Pink	Gb avant YCF50 2020 ROSE		1	AFTERMARKET
1	YC50-031-01-BL	Front Fender YCF50 2020 Blue	Gb avant YCF50 2020 Bleu		1	AFTERMARKET
1	YC50-031-01-GR	Front Fender YCF50 2020 Green	Gb avant YCF50 2020 VERT		1	AFTERMARKET
1	YC50-031-01-WH	Front Fender PP YCF50 2020 WHITE	Gb avant PP YCF50 2020 BLANC		1	AFTERMARKET
1	YC50-031-01-BK	Front Fender PP YCF50 2020 Black	Gb avant PP YCF50 2020 Noir		1	AFTERMARKET
2	GBT5787-M6x16-6-W	Hex. Bolt with flanged M6x16mm (step 6mm) steel	Vis avec epaulement M6x16mm (deport 6mm) acier		3	
3	GBT5787-M6x16-3-W	HEXAGON screw with Flange with half thread M6x16mmx3mm	Vis HEXAGONALE avec Flange et deport M6x16mmx3mm		2	

Front & Rear absorber



N°	Ref.	Description	Français	Picture	Qty/ Bike	MY
1	YC50-0400-03	Pair of fork L=530mm (not adjustable) MAGNESIUM	Jeu de fourche (non ajustable) L=530mm MAGNESIUM		1	



BIKE CODE FOR ORDERS		26-50A-STD	BIKE DESCRIPTION NAME	YCF 50A 2026	CONTROL STATUS	
EFFECTED DATE(D/M/Y)		22/1/2026	VERSION	2026A0		
2	YC50-0401-04	Front right fork L=530mm YCF50 2013 TITAN cylinder, Chrome tube, black base	tube fourche droit (non ajustable)L=530mm MAGNESIUM		1	
3	YC50-0402-04	Front left fork L=530mm YCF50 2013 TITAN cylinder, Chrome tube, black base	tube fourche gauche (non ajustable) L=530mm MAGNESIUM 2013		1	
4	YC50-0404-03	Shock absorber L=200mm YCF50 ZC YELLOW	Amortisseur L=200mm YCF50 ZC JAUNE		1	
5	YC50-0410-02	shock top spacer d10mmxd20mmx22mm YCF50 ZC	Entretoise haut amortisseur d10mmxd20mmx22mm YCF50 ZC		1	
6	YC50-0411-03	Shock bottom spacer d10mmxd20mmxd26x11mm YCF50 ZC	Entretoise bas amortisseur d10mmxd20mmxd26mmx11mm YCF50 ZC		2	
7	GB5789-M10x45-W-1.25	HEXAGON screw with Flange M10x1.25x45mm	Vis HEXAGONALE avec Flange M10x1.25x45mm		2	
8	GB6183-M10x1.25-Cr	Flanged nylon lock nut M10x1.25 Blue nylon chrome plated	Nylon de verrouillage en flange M10x1.25 Nylon Bleu Nylon		2	
9	YC50-0418-02-BK	530mm set of fork protection PP 200mm 2021 Black	530mm Jeu protection fourche PP 200mm 2021 Noir		1	
9	YC50-0418-02-GR	530mm set of fork protection PP 200mm 2021 GREEN	530mm Jeu protection fourche PP 200mm 2021 VERT		1	AFTERMARKET
9	YC50-0418-02-RD	530mm set of fork protection PP 200mm 2021 RED	530mm Jeu protection fourche PP 200mm 2021 ROUGE		1	AFTERMARKET
9	YC50-0418-02-YE	530mm set of fork protection PP 200mm 2021 YELLOW	530mm Jeu protection fourche PP 200mm 2021 JAUNE		1	AFTERMARKET
9	YC50-0418-02-OR	530mm set of fork protection PP 200mm 2021 ORANGE	530mm Jeu protection fourche PP 200mm 2021 ORANGE		1	AFTERMARKET
9	YC50-0418-02-WH	530mm set of fork protection PP 200mm 2021 WHITE	530mm Jeu protection fourche PP 200mm 2021 BLANC		1	AFTERMARKET
12	GB70.2-M5x10	Pan head hexagon screw inox M5x10mm	Vis à tête ronde Allen (BTR) inox M5x10mm		4	
13	GB97-d5-W	Flat washer, steel d5mm	Rondelle plate, acier d5mm		4	







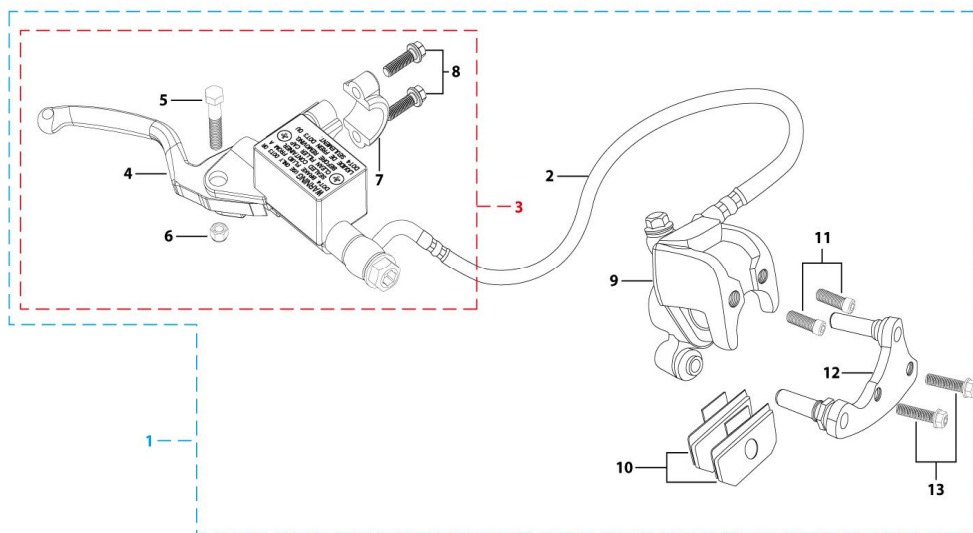









BIKE CODE FOR ORDERS		26-50A-STD	BIKE DESCRIPTION NAME	YCF 50A 2026	CONTROL STATUS	
EFFECTED DATE(D/M/Y)		22/1/2026	VERSION	2026A0		
14	YC110-0403-05	Complete Oil steel line retainer on left front fork PP START Black	Complet Passe durite sur protection fourche gauche PP START Noir		1	
14	YC110-0403-06-BK	Oil steel line retainer on left front fork CNC Black2020	Passe durite sur protection fourche gauche CNC Noir 2020		1	AFTERMARKET
14	YC110-0403-06-RD	Oil steel line retainer on left front fork CNC Red 2020	Passe durite sur protection fourche gauche CNC ROUGE 2020		1	AFTERMARKET
14	YC110-0403-06-OR	Oil steel line retainer on left front fork CNC Orange 2020	Passe durite sur protection fourche gauche CNC Orange 2020		1	AFTERMARKET
14	YC110-0403-06-BL	Oil steel line retainer on left front fork CNC Blue 2020	Passe durite sur protection fourche gauche CNC Bleu 2020		1	AFTERMARKET
14	YC110-0403-06-GR	Oil steel line retainer on left front fork CNC Green 2020	Passe durite sur protection fourche gauche CNC vert 2020		1	AFTERMARKET
14	YC110-0403-06-PU	Oil steel line retainer on left front fork CNC PURPLE 2020	Passe durite sur protection fourche gauche CNC VIOLET 2020		1	AFTERMARKET
17	BT08-M6x20-W	HEXAGON Torx screw with Flange M6x20mm	Vis HEXAGONALE Torx avec Flange M6x20mm		2	
18	GB6170-M6-W	HEXAGON Nut M6mm steel	Ecrou HEXAGONAL M6mm acier		2	

Front Brake Assy



N°	Ref.	Description	Français	Picture	Qty/ Bike	MY
----	------	-------------	----------	---------	--------------	----

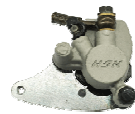

BIKE CODE FOR ORDERS		26-50A-STD	BIKE DESCRIPTION NAME	YCF 50A 2026	CONTROL STATUS	
EFFECTED DATE(D/M/Y)		22/1/2026	VERSION	2026A0		
1	YC50-0511-03	Front brake assy L=830mm YCF50A / 50E without asbestos d8mm/d8mm (right side) 2020	Kit frein avant L=830mm YCF50A / 50E sans amiante d8mm/d8mm (côté droit) 2020		1	
2	YC50-0504-06	Front brake oil steel line L=830mm d8mm/d8mm 50A 2020	Durite frein avant L=830mm d8mm/d8mm 50A 2020		1	
3	YC50-0501-0101	Front brake reservoir YCF50A / 50E (right side) 2020	Maitre cylindre frein avant YCF50A / 50E guidon (côté droit) 2020		1	
4	YC50-0503-05	Front Brake lever (right side) 50A 2020	Levier frein avant pour(côté droit) 50A 2020		1	
4	LFG50-1BK	HYDRAULIC LEFT FOLDABLE BRAKE FOR 50	FREIN HYDRAULIQUE GAUCHE POUR 50		1	AFTERMARKET
4	LFG50-1RD	HYDRAULIC LEFT FOLDABLE BRAKE FOR 50	FREIN HYDRAULIQUE GAUCHE POUR 50		1	AFTERMARKET
4	LFG50-1OR	HYDRAULIC LEFT FOLDABLE BRAKE FOR 50	FREIN HYDRAULIQUE GAUCHE POUR 50		1	AFTERMARKET
4	LFG50-1GR	HYDRAULIC LEFT FOLDABLE BRAKE FOR 50	FREIN HYDRAULIQUE GAUCHE POUR 50		1	AFTERMARKET
4	LFG50-1BL	HYDRAULIC LEFT FOLDABLE BRAKE FOR 50	FREIN HYDRAULIQUE GAUCHE POUR 50		1	AFTERMARKET
5	GB8752-M6x28-G	Hex head screw steel M6x28mm with step d8mmx14mm	Vis acier M6x28mm avec deport d8mmx14mm		1	
6	GB6184-M6-G	HEXAGON FLAT NYLON LOCK NUT M6-G	Ecrou HEXAGONAL autobloquant nylon M6-G		1	
8	GB70-M5x16	HEXAGON SOCKET Head Bolt, stainless steel, M5x16mm	Vis Allen (BTR)inox, M5x16mm		2	
9	YC50-0502-0101	Front Brake caliper YCF50A/50E single pump d8mm	Etrier frein avant YCF50A/50E simple pistons d8mm		1	
10	YC50-0506-02	Front / Rear Brake pads 50A/50E 2020	Jeu plaquette avant / arriere 50A/50E 2020		2	



BIKE CODE FOR ORDERS		26-50A-STD	BIKE DESCRIPTION NAME	YCF 50A 2026	CONTROL STATUS	
EFFECTED DATE(D/M/Y)		22/1/2026	VERSION	2026A0		
11	YC50-0555-01	Screw for front brake pads L=28mm	Vis plaquette frein avant L=28mm		2	
12	YC50-0510-01	Bracket for front brake single pumps 50A/50E 2020	Patte frein avant etrier simple pistons 50A/50E 2020		1	
13	BT08-M6x30-W	HEXAGON Torx screw with Flange M6x30mm	Vis HEXAGONALE Torx avec Flange M6x30mm		2	

Front Wheel Assy

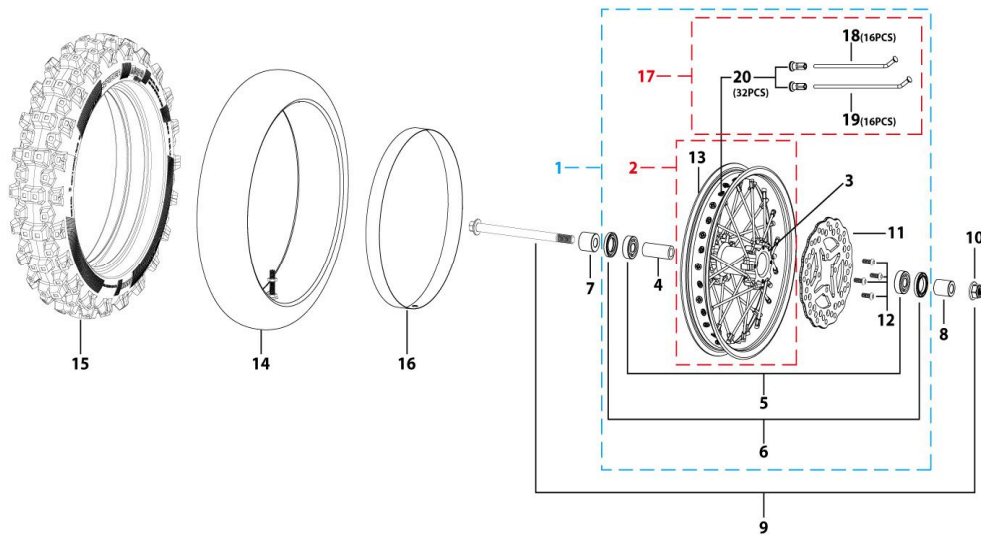

N°	Ref.	Description	Français	Picture	Qty/ Bike	MY
1	YC50-0601-0401	Complete STEEL Front wheel 1.40x10'(die cast hub, d160mm brake disk) YCF50 2020	Roue avant complète ACIER 1.40x10' (moyeux injecté cerceau avec d160mm disque) YCF50 2020		1	
1	YC50-0611-01-BK	Complete STEEL Front wheel YCF50 1.4x 10 with disk CNC hub BLACK / BLACK Rim	roue avant complète ACIER YCF50 1.4x10 avec disque moyeux CNC NOIR / Jante NOIRE		1	AFTERMAR KET
1	YC50-0611-01-BL	Complete STEEL Front wheel YCF50 1.4x 10 with disk CNC hub BLUE / BLACK Rim	roue avant complète ACIER YCF50 1.4x10 avec disque moyeux CNC BLEU / Jante NOIRE		1	AFTERMAR KET
1	YC50-0611-01-GR	Complete STEEL Front wheel YCF50 1.4x 10 with disk CNC hub GREEN / BLACK Rim	roue avant complète ACIER YCF50 1.4x10 avec disque moyeux CNC VERT / Jante NOIRE		1	AFTERMAR KET



BIKE CODE FOR ORDERS		26-50A-STD	BIKE DESCRIPTION NAME	YCF 50A 2026	CONTROL STATUS	
EFFECTED DATE(D/M/Y)		22/1/2026	VERSION	2026A0		
1	YC50-0611-01-OR	Complete STEEL Front wheel YCF50 1.4x 10 with disk CNC hub ORANGE / BLACK Rim	roue avant complète ACIER YCF50 1.4x10 avec disque moyeux CNC ORANGE / Jante NOIRE		1	AFTERMARKET
1	YC50-0611-01-RD	Complete STEEL Front wheel YCF50 1.4x 10 with disk CNC hub RED / BLACK Rim	roue avant complète ACIER YCF50 1.4x10 avec disque moyeux CNC ROUGE / Jante NOIRE		1	AFTERMARKET
3	YC50-0622-03	YCF50 Front hub injected with washer 2020	Moyeux avant injectée avec joint spy YCF50 2020		1	
3	YC50-0622-01-RD	Front hub CNC YCF50 Red	moyeux avant CNC YCF50 Rouge		1	AFTERMARKET
3	YC50-0622-01-OR	Front hub CNC YCF50 ORANGE	moyeux avant CNC YCF50 ORANGE		1	AFTERMARKET
3	YC50-0622-01-GR	Front hub CNC YCF50 GREEN	moyeux avant CNC YCF50 VERT		1	AFTERMARKET
3	YC50-0622-01-BL	Front hub CNC YCF50 BLUE	moyeux avant CNC YCF50 BLEU		1	AFTERMARKET
3	YC50-0622-01-BK	Front hub CNC YCF50 BLACK	moyeux avant CNC YCF50 NOIR		1	AFTERMARKET
4	YC50-0607-01	Front axle bushing 50A d12mmxd19mmx46mm	Entretoise central roue avant 50A d12mmxd19mmx46mm		1	
5	6201RS	Ball bearing 6201RS d12mmxd32mmx10mm	Roulement roue 6201RS d12mmxd32mmx10mm		2	
6	YC50-0610	OIL SEAL d22mmxd32mmx5mm	joint spy roue d22mmxd32mmx5mm		2	



BIKE CODE FOR ORDERS		26-50A-STD	BIKE DESCRIPTION NAME	YCF 50A 2026	CONTROL STATUS	
EFFECTED DATE(D/M/Y)		22/1/2026	VERSION	2026A0		
7	YC50-06-052	Front wheel spacer Right d12mmxd22mmx23mm	entretoise roue avant droite d12mmxd22mmx23mm		1	
8	YC50-06-051	Front wheel spacer left d12mmxd22mmx26mm	entretoise roue avant gauche d12mmxd22mmx26mm		1	
9	YC50-06-01	Front Axle L=170mm d12mm with Self-locking nut M12	Axe de roue avant L=170mm d12mm avec ecrou M12		1	
10	GB6187-M12-W	HEXAGON FLAT FLANGE LOCK NUT M12mm steel	Ecrou HEXAGONAL avec Flange autobloquant M12mm acier		1	
11	YC50-0513-01	Brake disk front/rear d160 mm T3.0mm 50A/50E	Disque frein avant/arriere d160mm T3.0mm 50A/50E		1	
12	GB70.2-M6x16	Pan head hexagon screw inox M6x16mm	Vis à tête ronde Allen (BTR) inox M6x16mm		4	
13	YC50-0617-01	STEEL Rim for Front wheel 1.4x10' Black	cerceau roue av 1,4x10' ACIER Noir		1	
13	YC50-0617-02	Rim 1.4x10 Alu Black	cerceau1,40x10 Alu Noir		1	AFTERMARKET
14	CHAMBRE10-2.5N	Tube for front/rear tire 2.50x10' (Air cock 90°)	chambre air avant/arriere 2.50x10' 90°		1	
15	250/10	Tire front/rear 2.50x10' JUNXI	pneu avant/arriere 2.50x10' JUNXI		1	
	TVC-RD	Tire valve caps 2PCS RED	Embout Valve Chambre a Air CNC ROUGE		1	AFTERMARKET
	TVC-OR	Tire valve caps 2PCS ORANGE	Embout Valve Chambre a Air CNC ORANGE		1	AFTERMARKET
	TVC-GR	Tire valve caps 2PCS GREEN	Embout Valve Chambre a Air CNC VERT		1	AFTERMARKET



BIKE CODE FOR ORDERS		26-50A-STD	BIKE DESCRIPTION NAME	YCF 50A 2026	CONTROL STATUS	
EFFECTED DATE(D/M/Y)		22/1/2026	VERSION	2026A0		
	TVC-BL	Tire valve caps 2PCS BLUE	Embout Valve Chambre a Air CNC BLEU		1	AFTERMARKET
	TVC-BK	Tire valve caps 2PCS BLACK	Embout Valve Chambre a Air CNC NOIR		1	AFTERMARKET
	TVC-PU	Tire valve caps 2PCS PURPLE	Embout Valve Chambre a Air CNC PURPLE		1	AFTERMARKET
16	YC110-11-02	Tire lining 10'x18	fond jante 10'x18		1	
17	JR10-10.6	set of spoke 50CC 1.4x10' (104mmx16+106mmx16) (3.2mm)	JEUX RAYON AV 10' 50CC 1.4x10' (104mmx16+106mmx16) (3.2mm)		1	
	SPKAS01-YE	SPOKE SKINS ASSY FRONT L=215mmx38PCS REAR L=190 mmx38PCS YELLOW	Kit de couvre rayons AVANT: 215 mmx38PCS ARRIERE : 190mmx38PCS JAUNE		1	AFTERMARKET
	SPKAS01-RD	SPOKE SKINS ASSY FRONT L=215mmx38PCS REAR L=190 mmx38PCS RED	Kit de couvre rayons AVANT: 215 mmx38PCS ARRIERE : 190mmx38PCS ROUGE		1	AFTERMARKET
	SPKAS01-GR	SPOKE SKINS ASSY FRONT L=215mmx38PCS REAR L=190 mmx38PCS GREEN	Kit de couvre rayons AVANT: 215 mmx38PCS ARRIERE : 190mmx38PCS VERT		1	AFTERMARKET
	SPKAS01-BL	SPOKE SKINS ASSY FRONT L=215mmx38PCS REAR L=190 mmx38PCS BLUE	Kit de couvre rayons AVANT: 215 mmx38PCS ARRIERE : 190mmx38PCS BLEU FONCE		1	AFTERMARKET
	SPKAS01-PK	SPOKE SKINS ASSY FRONT L=215mmx38PCS REAR L=190 mmx38PCS PINK	Kit de couvre rayons AVANT: 215 mmx38PCS ARRIERE : 190mmx38PCS ROSE		1	AFTERMARKET
	SPKAS01-OR	SPOKE SKINS ASSY FRONT L=215mmx38PCS REAR L=190 mmx38PCS ORANGE	Kit de couvre rayons AVANT: 215 mmx38PCS ARRIERE : 190mmx38PCS ORANGE		1	AFTERMARKET
	SPKAS01-BK	SPOKE SKINS ASSY FRONT L=215mmx38PCS REAR L=190 mmx38PCS BLACK	Kit de couvre rayons AVANT: 215 mmx38PCS ARRIERE : 190mmx38PCS NOIR		1	AFTERMARKET

Fuel Tank



BIKE CODE FOR ORDERS	26-50A-STD	BIKE DESCRIPTION NAME	YCF 50A 2026	CONTROL STATUS
EFFECTED DATE(D/M/Y)	22/1/2026	VERSION	2026A0	

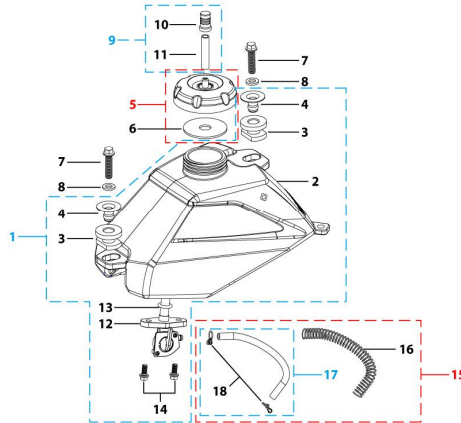

N°	Ref.	Description	Français	Picture	Qty/ Bike	Rep. Pst.
1	YC50-07012-01	Complete fuel tank YCF50A 2025 WITH HOLES(with YC110-07-01 2EA+YC110-07-02 2EA)	Reservoir complet YCF50A 2025AVEC TROU(avec YC110-07-01 2EA+YC110-07-02 2EA)		1	
5	YC110-0702-01	Tank cap plastic Ventilator d3mm	Bouchon reservoir plastique YCF d3mm		1	
7	BT08-M8x30-W	HEXAGON Torx screw with Flange M8x30mm	Vis HEXAGONALE Torx avec Flange M8x30mm		2	
8	GB97-d8-2W	Flat washer,steel d8mm 2W	Rondelle plate,acier d8mm 2W		2	
9	YC125-0704-BK	Fuel tank valve complete L=40mm Black	Valve prise air complete L=40mm Noir		1	
10	YC125-0704-BL	Fuel tank valve Blue	Valve prise air Bleu		1	AFTERMAR KET
10	YC125-0704-RD	Fuel tank valve Red	Valve prise air Rouge		1	AFTERMAR KET
10	YC125-0704-GR	Fuel tank valve Green	Valve prise air Vert		1	AFTERMAR KET
10	YC125-0704-OR	Fuel tank valve Orange	Valve prise air Orange		1	AFTERMAR KET
10	YC125-0704-PU	Fuel tank valve PURPLE	Valve prise air VIOLET		1	AFTERMAR KET
12	YC110-0703	Fuel cock assy.	robinet essence		1	



BIKE CODE FOR ORDERS		26-50A-STD	BIKE DESCRIPTION NAME	YCF 50A 2026	CONTROL STATUS	
EFFECTED DATE(D/M/Y)		22/1/2026	VERSION	2026A0		
14	GB5787-M6x12-W	HEXAGON screw with Flange M6x12mm steel	Vis HEXAGONALE avec Flange M6x12mm acier		2	
15	YC110-0706	fuel tank rubber line spring d4.5mmxd8.5mmx210mm	durite reservoir avec ressort d4.5mmxd8.5mmx210mm		1	
18	DC-WH	Fuel line White L=1000mm	Durite essence White L=1000mm		1	AFTERMARKET
18	DC-RD	Fuel line Red L=1000mm	Durite essence Rouge L=1000mm		1	AFTERMARKET
18	DC-PK	Fuel line PINK L=1000mm	Durite essence ROSE L=1000mm		1	AFTERMARKET
18	DC-BL	Fuel line Blue L=1000mm	Durite essence Bleu L=1000mm		1	AFTERMARKET
18	DC-GR	Fuel line Green L=1000mm	Durite essence vert L=1000mm		1	AFTERMARKET
18	DC-YE	Fuel line Yellow L=1000mm	Durite essence jaune L=1000mm		1	AFTERMARKET
18	DC-OR	Fuel line Orange L=1000mm	Durite essence Orange L=1000mm		1	AFTERMARKET
18	DC-BK	Fuel line Black L=1000mm	Durite essence NOIR L=1000mm		1	AFTERMARKET

Air Filter/CARBU

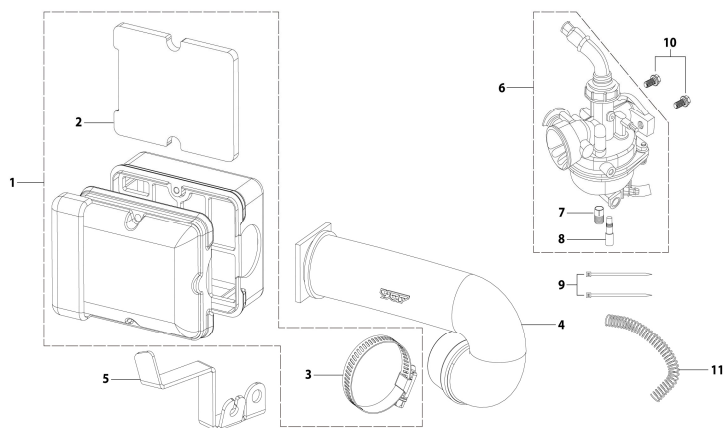



BIKE CODE FOR ORDERS		26-50A-STD	BIKE DESCRIPTION NAME	YCF 50A 2026	CONTROL STATUS	
EFFECTED DATE(D/M/Y)		22/1/2026	VERSION	2026A0		
N°	Ref.	Description	Français	Picture	Qty/ Bike	MY
1	YC50-0801	Air box air filter assy d28	filtre air complet boite a air d28		1	
2	YC50-0802	Air filter Foam 50A	Mousse filtre a air 50A		1	
3	YC50-0803-01	Holding ring d25mm-d40mm	collier FILTRE d25mm-d40mm		1	
4	YC50-0805-01	50A rubber connexion for air box, 2022	Manchon boite air 50A, 2022		1	
5	YC110-0835-02	YCF50 Air box fixed bracket	Plaque acier maintien boite air YCF50		1	
6	YC50-20-31	Carburetor 5012 with main jet 50	Carburateur 5012 GICLEUR 50		1	
7	GICLEUR50-02	main jet for 50A	GICLEUR for 50A		1	
8	GICLEUR33	Slow Jet 33 FLK Nibbi	GICLEUR 33		1	
9	YC110-01-03-WH	Cable tie,nylon, L=150mm WHITE	collier maintien cable, nylon, L=150mm BLANC		2	
10	BT08-M6x25-W	HEXAGON Torx screw with Flange M6x25mm	Vis HEXAGONALE Torx avec Flange M6x25mm		2	
11	YC110-07061	fuel tank spring L=180mm	ressort durite reservoir L=180mm		1	
Foot Peg assy						



BIKE CODE FOR ORDERS	26-50A-STD	BIKE DESCRIPTION NAME	YCF 50A 2026	CONTROL STATUS
EFFECTED DATE(D/M/Y)	22/1/2026	VERSION	2026A0	

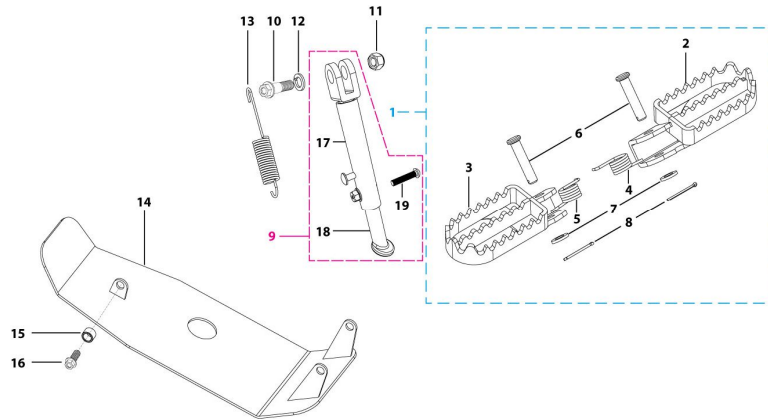

N°	Ref.	Description	Français	Picture	Qty/ Bike	Rep. Pst.
1	YC50-0902-04	Steel set of foot pegs 50cc Grey 2020	jeu repose pied acier 50cc Grise 2020		1	
4	YC110-09-01	Spring for right steel foot peg d2mmxd17mmx12mm	ressort repose pied droit acier d2mmxd17mmx12mm		1	
5	YC110-09-02	Spring for left steel foot peg d2mmxd17mmx12mm	ressort repose pied gauche acier d2mmxd17mmx12mm		1	
6	GB882-d8x40-W	shaft pin for steel footpegs d8mmx40mm	axe repose pied acier d8mmx40mm		2	
7	GB97-d8-W	Flat washer, steel d8mm	Rondelle plate, acier d8mm		2	
8	GB91-d2x25-W	Split pin d2.0mmx25mm	Goupille d2.0mmx25mm		2	
9	YC50-210-01	Adjustable stand L=180mm- L=240mm adjustable 2024 Black	Bequille réglable L=180mm- L=240mm réglable 2024 Noir		1	
19	GB70.2-M6x30	Pan head hexagon screw inox M6x30mm	Vis à tête ronde Allen (BTR) inox M6x30mm		1	
10	FB02-M10x1.5x30I	Stepped screw M10x35mm for kick stand (step 1.5)	vis bequille M10x35mm (pas1.5)		1	
11	GB6172-M10-G	HEXAGON Nut M10 for #17 sleeve	Ecrou HEXAGONAL M10 for #17 sleeve		1	
12	GB93-d10-W	Spring Lock Washers d10mm	Rondelle a ressort d10mm		1	
13	YC110-19-01	spring for kick stand d2.5mmxd15mmx105mm	ressort bequille d2.5mmxd15mmx105mm		1	



BIKE CODE FOR ORDERS		26-50A-STD	BIKE DESCRIPTION NAME	YCF 50A 2026	CONTROL STATUS	
EFFECTED DATE(D/M/Y)		22/1/2026	VERSION	2026A0		
14	YC50-204-01	YCF50 Engine skid plate steel T=2mm MATTE Black	sabot acier YCF50 T=2mm Noir MAT		1	
15	FB13-8.5x10x10-W	bushing skid plate d8.5mmxd10mmx10mm	Entretoise Bras acier d8.5mmxd10mmx10mm		1	
16	BT08-M8x20-W	HEXAGON Torx screw with Flange M8x20mm	Vis HEXAGONALE Torx avec Flange M8x20mm		1	

Swing Arm assy

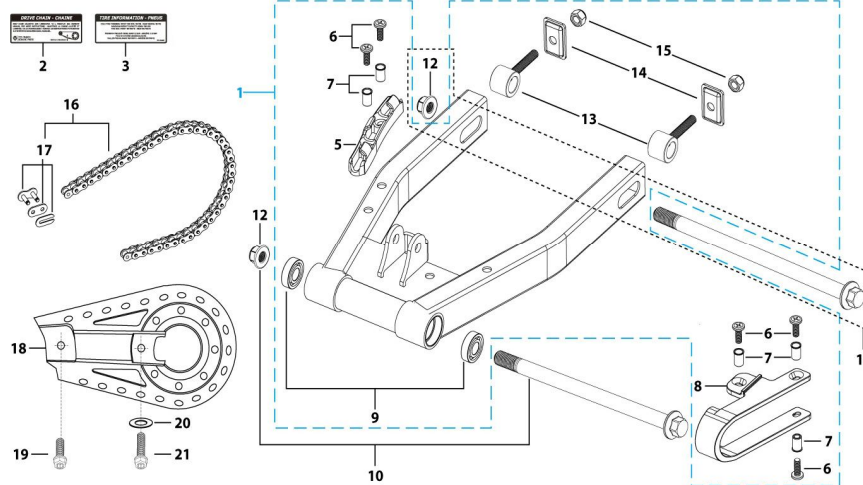

N°	Ref.	Description	Français	Picture	Qty/ Bike	MY
1	YC50-10014-0101	YCF50 Mono swing arm Black L=290mm d12mm adjustable 2 height 2024	Bras oscillant mono YCF50 Noir L=290mm d12mm ajustable 2 hauteurs 2024		1	
5	YC110-10-015-BK	Rear brake hose guide 2020 Black	Passe durite de frein arriere sur bras oscillant 2020 Noir		1	
6	DIN7985-M6x16	Screw M6x16mm inox	Vis M6x16mm inox		5	
8	YC50-10-01	Chain slider for Steel swing arm PU 50A	patin chaine court pour bras Acier PU 50A		1	
9	6001/28-12-08	Swing arm ball bearing 6001 d12mmxd28mmx8mm	Roulement bras oscillant 6001 d12mmxd28mmx8mm		2	
10	YC110-10-034	Swing arm shaft with self lock nut M12 L=192mm d12	axe bras oscillant d12 avec ecrou M12 L=192mm		1	
11	YC50-11-01	Rear wheel axle L=220 d12mm with Self locking nut M12	axe roue arriere L=220 d12mm avec ecrou M12		1	



BIKE CODE FOR ORDERS		26-50A-STD	BIKE DESCRIPTION NAME	YCF 50A 2026	CONTROL STATUS	
EFFECTED DATE(D/M/Y)		22/1/2026	VERSION	2026A0		
12	GB6187-M12-W	HEXAGON FLAT FLANGE LOCK NUT M12mm steel	Ecrou HEXAGONAL avec Flange autobloquant M12mm acier		1	
13	YC50-1001-001	Block axle d13.5mm YCF50 Black	Tendeur chaine d13.5mm YCF50 Noir		2	
	YC50-1001-003	Black axle fixing plate Black 2020	Patte acier fixation tendeur chaine Noir 2020		2	
15	GB6189-M8-W	HEXAGON NUT M8	Ecrou Hexagonal M8		2	
16	420H-82	YCF50 Driving chain 420H-82T	Chaîne 420H-82T maillons YCF50		1	
16	420-82-BL	Chain 420H-82, ordinary, BLUE	Chaîne 420 82 maillons standard BLEU		1	AFTERMARKET
16	420-82-GR	Chain 420H-82, ordinary, GREEN	Chaîne 420 82 maillons standard VERT		1	AFTERMARKET
16	420-82-RD	Chain 420H-82, ordinary, RED	Chaîne 420 82 maillons standard ROUGE		1	AFTERMARKET
16	420-82-YE	Chain 420H-82, ordinary, YELLOW	Chaîne 420 82 maillons standard JAUNE		1	AFTERMARKET
16	420-82-OR	Chain 420H-82, ordinary, ORANGE	Chaîne 420 82 maillons standard ORANGE		1	AFTERMARKET
17	AR-420	Chain link H=17mm	Attache rapide chaine H=17mm		1	
18	YC50-0600-02	Chain box protection L=152mm	Protection chaine plastique L=152mm		1	
19	GB5787-M6x10-W	HEXAGON screw with Flange M6x10mm steel	Vis HEXAGONALE avec Flange M6x10mm acier		1	
20	FB13-7x12x5.5	Bushing d7mmxd12mmx5.5mm for gearshift tube	Entretoise d7mmxd12mmx5.5mm pour tige de selecteur		1	
21	GB5787-M6x16-W	HEXAGON screw with Flange M6x16mm steel	Vis HEXAGONALE avec Flange M6x16mm acier		1	
Rear Wheel Assy						





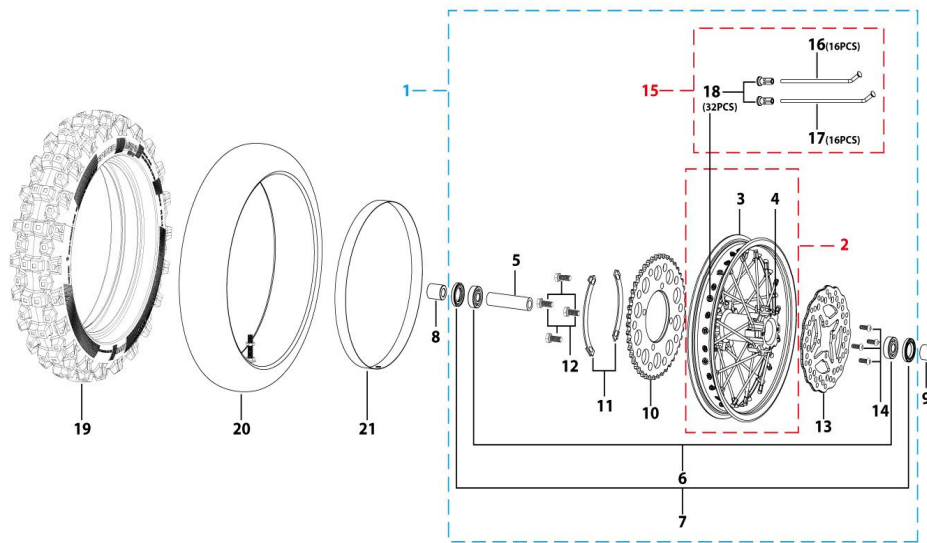

BIKE CODE FOR ORDERS	26-50A-STD	BIKE DESCRIPTION NAME	YCF 50A 2026	CONTROL STATUS
EFFECTED DATE(D/M/Y)	22/1/2026	VERSION	2026A0	



N°	Ref.	Description	Français	Picture	Qty/ Bike	MY
1	YC50-1101-0401	YCF50 Complete STEEL Rear wheel 1.4x10' Casting hub with disk 45T 2020	roue arriere complète YCF50 Acier 1.4x10' moyeux injecte avec disque 45T 2020		1	
1	YC50-1101-BK	Complete STEEL Rear wheel 1.40-10' with disk CNC BLACK hub / BLACK Rim	roue arriere complète ACIER 1.40-10 avec disque moyeux CNC NOIR / Jante NOIRE		1	AFTERMARKET
1	YC50-1101-BL	Complete STEEL Rear wheel 1.40-10' with disk CNC BLUE hub BLACK Rim	roue arriere complète ACIER 1.40-10 avec disque moyeux CNC BLEU / Jante NOIRE		1	AFTERMARKET
1	YC50-1101-GR	Complete STEEL Rear wheel 1.40-10' with disk CNC GREEN hub BLACK Rim	roue arriere complète ACIER 1.40-10 avec disque moyeux CNC VERT / Jante NOIRE		1	AFTERMARKET
1	YC50-1101-OR	Complete STEEL Rear wheel 1.40-10' with disk CNC ORANGE hub BLACK Rim	roue arriere complète ACIER 1.40-10 avec disque moyeux CNC ORANGE / Jante NOIRE		1	AFTERMARKET
1	YC50-1101-RD	Complete STEEL Rear wheel 1.40-10' with disk CNC RED hub BLACK Rim	roue arriere complète ACIER 1.40-10 avec disque moyeux CNC ROUGE / Jante NOIRE		1	AFTERMARKET
3	YC50-0617-01	STEEL Rim for Front wheel 1.4x10' Black	cerceau roue av 1,4x10' ACIER Noir		1	



BIKE CODE FOR ORDERS		26-50A-STD	BIKE DESCRIPTION NAME	YCF 50A 2026	CONTROL STATUS	
EFFECTED DATE(D/M/Y)		22/1/2026	VERSION	2026A0		
13	YC50-0617-02	Rim 1.4x10 Alu Black	cerceau1,40x10 Alu Noir		1	AFTERMARKET
4	YC50-1122-04	YCF50 Rear wheel die cast hub with seal 2022	Moyeux arrière YCF50 injecte avec joint spy 2022		1	
4	YC50-1122-01-RD	Rear hub CNC YCF50 RED	moyeux arrière CNC YCF50 ROUGE		1	AFTERMARKET
4	YC50-1122-01-OR	Rear hub CNC YCF50 ORANGE	moyeux arrière CNC YCF50 ORANGE		1	AFTERMARKET
4	YC50-1122-01-GR	Rear hub CNC YCF50 GREEN	moyeux arrière CNC YCF50 VERT		1	AFTERMARKET
4	YC50-1122-01-BL	Rear hub CNC YCF50 BLUE	moyeux arrière CNC YCF50 BLEU		1	AFTERMARKET
4	YC50-1122-01-BK	Rear hub CNC YCF50 BLACK	moyeux arrière CNC YCF50 NOIR		1	AFTERMARKET
5	YC50-1109-01	Rear hub axle bushing 6061 d12mmxd19mmx76mm	Entretoise intérieur moyeux arrière 6061 d12mmxd19mmx76mm		1	
6	6201RS	Ball bearing 6201RS d12mmxd32mmx10mm	Roulement roue 6201RS d12mmxd32mmx10mm		2	
7	YC50-0610	OIL SEAL d22mmxd32mmx5mm	joint spy roue d22mmxd32mmx5mm		2	
8	YC50-11-041	Rear wheel spacer left Q235 d22mmxd12mmx25mm	Entretoise roue arriere gauche Q235 d22mmxd12mmx25mm		1	
9	YC50-11-043	Rear wheel spacer right Q235 d12mmxd22mmx17mm	Entretoise roue arriere droit Q235 d12mmxd22mmx17mm		1	



BIKE CODE FOR ORDERS		26-50A-STD	BIKE DESCRIPTION NAME	YCF 50A 2026	CONTROL STATUS	
EFFECTED DATE(D/M/Y)		22/1/2026	VERSION	2026A0		
10	YC110-11-06/45	YCF Driven sprocket 420-45T (4 holes)	couronne acier 420-45T YCF		1	
	YC110-11-05-39	YCF Driven sprocket 420- 39T	couronne acier 420- 39T		1	AFTERMAR KET
10	YC110-11-06/41	YCF Driven sprocket 420-41T (4 holes)	couronne acier 420-41T YCF (4 trous)		1	AFTERMAR KET
10	YC110-11-062/47	YCF Driven sprocket 420-47T 5 holes	Couronne acier 420-47T YCF		1	AFTERMAR KET
	CA06R32-BK	CNC SPROCKET 32 2023 BLACK	COURONNE ALU 32 2023 NOIR		1	AFTERMAR KET
	CA06R34-BK	CNC SPROCKET 34 2023 BLACK	COURONNE ALU 34 2023 NOIR		1	AFTERMAR KET
	CA06R35-BK	CNC SPROCKET 35 2023 BLACK	COURONNE ALU 35 2023 NOIR		1	AFTERMAR KET
	CA06R36-BK	CNC SPROCKET 36 2023 BLACK	COURONNE ALU 36 2023 NOIR		1	AFTERMAR KET
14	CA06R37-BK	CNC SPROCKET 37 BLACK 2014	COURONNE ALU 37 NOIR 2014		1	AFTERMAR KET
14	CA06R37-BL	CNC SPROCKET 37 BLUE 2014	COURONNE ALU 37 BLEU 2014		1	AFTERMAR KET
14	CA06R37-GR	CNC SPROCKET 37 GREEN 2014	COURONNE ALU 37 VERT 2014		1	AFTERMAR KET
14	CA06R37-OR	CNC SPROCKET 37 ORANGE 2014	COURONNE ALU 37 ORANGE 2014		1	AFTERMAR KET
14	CA06R37-RD	CNC SPROCKET 37 RED 2014	COURONNE ALU 37 ROUGE 2014		1	AFTERMAR KET
14	CA06R39-BK	CNC SPROCKET 39 BLACK 2014	COURONNE ALU 39 NOIR 2014		1	AFTERMAR KET
14	CA06R39-BL	CNC SPROCKET 39 BLUE 2014	COURONNE ALU 39 BLEU 2014		1	AFTERMAR KET
14	CA06R39-GR	CNC SPROCKET 39 GREEN 2014	COURONNE ALU 39 VERT 2014		1	AFTERMAR KET
14	CA06R39-OR	CNC SPROCKET 39 ORANGE 2014	COURONNE ALU 39 ORANGE 2014		1	AFTERMAR KET



BIKE CODE FOR ORDERS		26-50A-STD	BIKE DESCRIPTION NAME	YCF 50A 2026	CONTROL STATUS	
EFFECTED DATE(D/M/Y)		22/1/2026	VERSION	2026A0		
14	CA06R39-RD	CNC SPROCKET 39 RED 2014	COURONNE ALU 39 ROUGE 2014		1	AFTERMARKET
14	CA06R41-BK	CNC SPROCKET 41 BLACK 2014	COURONNE ALU 41 NOIR 2014		1	AFTERMARKET
14	CA06R41-BL	CNC SPROCKET 41 BLUE 2014	COURONNE ALU 41 BLEU 2014		1	AFTERMARKET
14	CA06R41-GR	CNC SPROCKET 41 GREEN 2014	COURONNE ALU 41 VERT 2014		1	AFTERMARKET
14	CA06R41-OR	CNC SPROCKET 41 ORANGE 2014	COURONNE ALU 41 ORANGE 2014		1	AFTERMARKET
14	CA06R41-RD	CNC SPROCKET 41 RED 2014	COURONNE ALU 41 ROUGE 2014		1	AFTERMARKET
14	CA06R43-BK	CNC SPROCKET 43 BLACK 2014	COURONNE ALU 43 NOIR 2014		1	AFTERMARKET
14	CA06R43-BL	CNC SPROCKET 43 BLUE 2014	COURONNE ALU 43 BLEU 2014		1	AFTERMARKET
14	CA06R43-GR	CNC SPROCKET 43 GREEN 2014	COURONNE ALU 43 VERT 2014		1	AFTERMARKET
14	CA06R43-OR	CNC SPROCKET 43 ORANGE 2014	COURONNE ALU 43 ORANGE 2014		1	AFTERMARKET
14	CA06R43-RD	CNC SPROCKET 43 RED 2014	COURONNE ALU 43 ROUGE 2014		1	AFTERMARKET
14	CA06R45-BK	CNC SPROCKET 45 BLACK 2014	COURONNE ALU 45 NOIR 2014		1	AFTERMARKET
14	CA06R45-BL	CNC SPROCKET 45 BLUE 2014	COURONNE ALU 45 BLEU 2014		1	AFTERMARKET
14	CA06R45-GR	CNC SPROCKET 45 GREEN 2014	COURONNE ALU 45 VERT 2014		1	AFTERMARKET
14	CA06R45-OR	CNC SPROCKET 45 ORANGE 2014	COURONNE ALU 45 ORANGE 2014		1	AFTERMARKET
14	CA06R45-RD	CNC SPROCKET 45 RED 2014	COURONNE ALU 45 ROUGE 2014		1	AFTERMARKET
14	CA06R47-BK	CNC SPROCKET 47 BLACK 2014	COURONNE ALU 47 NOIR 2014		1	AFTERMARKET
14	CA06R47-BL	CNC SPROCKET 47 BLUE 2014	COURONNE ALU 47 BLEU 2014		1	AFTERMARKET
14	CA06R47-GR	CNC SPROCKET 47 GREEN 2014	COURONNE ALU 47 VERT 2014		1	AFTERMARKET
14	CA06R47-OR	CNC SPROCKET 47 ORANGE 2014	COURONNE ALU 47 ORANGE 2014		1	AFTERMARKET
14	CA06R47-RD	CNC SPROCKET 47 RED 2014	COURONNE ALU 47 ROUGE 2014		1	AFTERMARKET
11	YC110-11-03	Sprocket Locking piece	block couronne		2	
12	GB5783-M8x20-W	Hexagon Head Bolt with full thread M8x20mm	Vis a tete HEXAGONALE M8x20mm		4	



BIKE CODE FOR ORDERS		26-50A-STD	BIKE DESCRIPTION NAME	YCF 50A 2026	CONTROL STATUS	
EFFECTED DATE(D/M/Y)		22/1/2026	VERSION	2026A0		
13	YC50-0513-01	Brake disk front/rear d160 mm T3.0mm 50A/50E	Disque frein avant/arriere d160mm T3.0mm 50A/50E		1	
14	GB70.2-M6x16	Pan head hexagon screw inox M6x16mm	Vis à tête ronde Allen (BTR) inox M6x16mm		4	
15	JR10-10.5	set of spoke 10' (106mmx16+111mmx16) 10K(3.2mm)	jeu rayon arriere 10' (106mmx16+111mmx16) 10K(3.2mm)		1	
19	250/10	Tire front/rear 2.50x10' JUNXI	pneu avant/arriere 2.50x10' JUNXI		1	
	90/90-10K702	SM FRONT AND REAR TIRE KENDA 90/90-10	PNEU SM AV ET AR KENDA 90/90- 10		1	AFTERMAR KET
20	CHAMBRE10-2.5N	Tube for front/rear tire 2.50x10' (Air cock 90°)	chambre air avant/arriere 2.50x10' 90°		1	
21	YC110-11-02	Tire lining 10'x18	fond jante 10'x18		1	
	TVC-RD	Tire valve caps 2PCS RED	Embout Valve Chambre a Air CNC ROUGE		1	AFTERMAR KET
	TVC-OR	Tire valve caps 2PCS ORANGE	Embout Valve Chambre a Air CNC ORANGE		1	AFTERMAR KET
	TVC-GR	Tire valve caps 2PCS GREEN	Embout Valve Chambre a Air CNC VERT		1	AFTERMAR KET
	TVC-BL	Tire valve caps 2PCS BLUE	Embout Valve Chambre a Air CNC BLEU		1	AFTERMAR KET
	TVC-BK	Tire valve caps 2PCS BLACK	Embout Valve Chambre a Air CNC NOIR		1	AFTERMAR KET
	TVC-PU	Tire valve caps 2PCS PURPLE	Embout Valve Chambre a Air CNC PURPLE		1	AFTERMAR KET
REAR BRAKE						





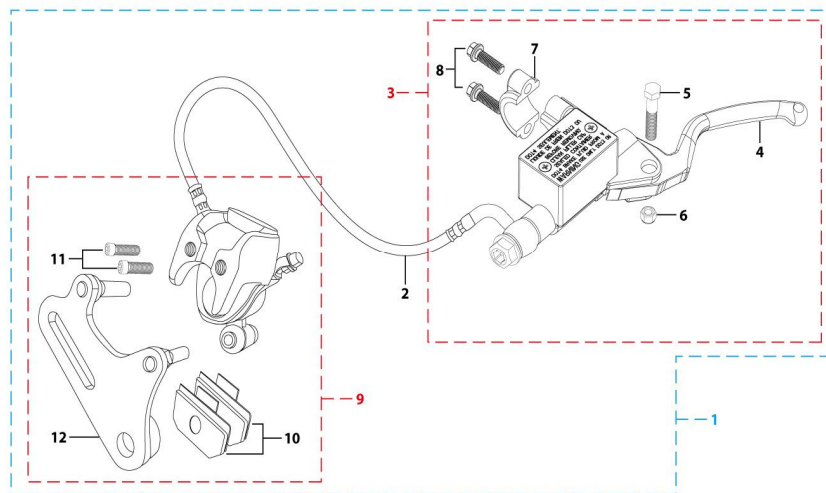

BIKE CODE FOR ORDERS	26-50A-STD	BIKE DESCRIPTION NAME	YCF 50A 2026	CONTROL STATUS
EFFECTED DATE(D/M/Y)	22/1/2026	VERSION	2026A0	



N°	Ref.	Description	Français	Picture	Qty/ Bike	MY
1	YC50-1214-03	Rear brake assy YCF50A / 50E d8mm/d8mm L=1070mm (left side)2020	Kit frein arriere YCF50A / 50E d8mm/d8mm L=1070mm (côté gauche) 2020		1	
2	YC50-1203-04	YCF50 Rear brake steel line L=1070mm d8mm/d8mm 50A/50E 2020	Durite frein arriere L=1070mm 50A/50E d8mm/d8mm 2020		1	
3	YC50-1202-02	Rear brake reservoir YCF50A / 50E (left side) 2020	Maitre cylindre frein arriere YCF50A / 50E guidon (côté gauche) 2020		1	
4	YC50-0503-06	REAR Brake lever(left side) 50A 2020	Levier frein arriere pour (côté gauche) 50A 2020		1	
4	LFD50-1BK	HYDRAULIC RIGHT BRAKE LEVER FOR 50	LEVIER FREIN DROIT PLIABLE POUR 50 HYDRAULIQUE		1	AFTERMARKET
4	LFD50-1RD	HYDRAULIC RIGHT BRAKE LEVER FOR 50	LEVIER FREIN DROIT PLIABLE POUR 50 HYDRAULIQUE		1	AFTERMARKET
4	LFD50-1OR	HYDRAULIC RIGHT BRAKE LEVER FOR 50	LEVIER FREIN DROIT PLIABLE POUR 50 HYDRAULIQUE		1	AFTERMARKET
4	LFD50-1GR	HYDRAULIC RIGHT BRAKE LEVER FOR 50	LEVIER FREIN DROIT PLIABLE POUR 50 HYDRAULIQUE		1	AFTERMARKET
4	LFD50-1BL	HYDRAULIC RIGHT BRAKE LEVER FOR 50	LEVIER FREIN DROIT PLIABLE POUR 50 HYDRAULIQUE		1	AFTERMARKET
5	GB8752-M6x28-G	Hex head screw steel M6x28mm with step d8mmx14mm	Vis acier M6x28mm avec deport d8mmx14mm		1	
6	GB6189-M6-W	HEXAGON NUT M6	Ecrou Hexagonal M6		1	
8	GB70-M5x16	HEXAGON SOCKET Head Bolt, stainless steel, M5x16mm	Vis Allen (BTR)inox, M5x16mm		2	







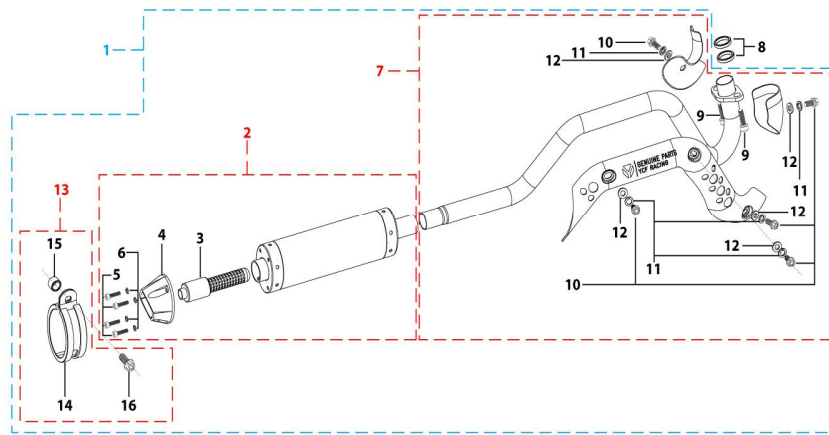



BIKE CODE FOR ORDERS		26-50A-STD	BIKE DESCRIPTION NAME	YCF 50A 2026	CONTROL STATUS	
EFFECTED DATE(D/M/Y)		22/1/2026	VERSION	2026A0		
9	YC50-1201-02	Rear Brake caliper YCF50A/50E d8 (left side) 2020	Etrier Frein arriere YCF50A/50E d8 (côté gauche) 2020		1	
10	YC50-0506-02	Front / Rear Brake pads 50A/50E 2020	Jeu plaquette avant / arriere 50A/50E 2020		2	
11	YC50-0555-01	Screw for front brake pads L=28mm	Vis plaquette frein avant L=28mm		2	
12	YC50-120101-03	Rear brake bracket YCF50A/50E (left side) 2020	Patte fixation étrier frein arriere YCF50A/50E (côté gauche)2020		1	

Exhaust system



N°	Ref.	Description	Français	Picture	Qty/ Bike	MY
1	YC50-132-03-GY	YCF50 Muffler& Exhaust pipe assy 2020 GREY	Echappement complet YCF50 2020 GRISE		1	
2	YC50-13016-GY	YCF50 Muffler L=240mm GREY	Silencieux YCF50 GRIS L=240mm		1	
3	YC50-13-30	YCF50 Noise reducer (spark arrestor)	Bride de pot YCF50		1	
4	YC50-13-33	YCF50 Muffler end cap YCF	Embout silencieux YCF50		1	
5	GB70-M4x16	HEXAGON SOCKET Head Bolt, stainless steel, M4x16mm	Vis Allen (BTR)inox, M4x16mm		4	
6	GB93-d4-W	Spring Lock Washers d4mm	Rondelle a ressort d4mm		4	



BIKE CODE FOR ORDERS		26-50A-STD	BIKE DESCRIPTION NAME	YCF 50A 2026	CONTROL STATUS	
EFFECTED DATE(D/M/Y)		22/1/2026	VERSION	2026A0		
7	YC50-13010-03-GY	Exhaust pipe d22mm 2020 Grey	collecteur d22mm 2020 Gris		1	
8	YC50-1304	Exhaust pipe washer d17mmxd22mmx4mm	joint pot d17mmxd22mmx4mm		2	
9	GB70-M6x20	HEXAGON SOCKET Head Bolt, stainless steel, M6x20mm	Vis Allen (BTR)inox, M6x20mm		2	
10	BT08-M6x10-W	HEXAGON Torx screw with Flange M6x10mm	Vis HEXAGONALE Torx avec Flange M6x10mm		5	
11	GB93-d6-W	Spring Lock Washers d6mm	Rondelle a ressort d6mm		5	
12	GB97-d6-W	Flat washer, steel d6mm	Rondelle plate, acier d6mm		5	
13	YC50-13-02	Hoop for muffler YCF50(with FB13-d10xd14x10-W 1EA+BT08-M8x30-W 1EA)	Attache silencieux YCF50 complet		1	
15	FB13-10x14x10-W	bushing (Muffler Hoop spacer /chain tensioner) d10mmxd14mmx10mm	Entretoise attache silencieux /roulette de chaine d10mmxd14mmx10mm		1	
16	BT08-M8x25-W	HEXAGON Torx screw with Flange M8x25mm	Vis HEXAGONALE Torx avec Flange M8x25mm		1	

Seat & Plastic kit

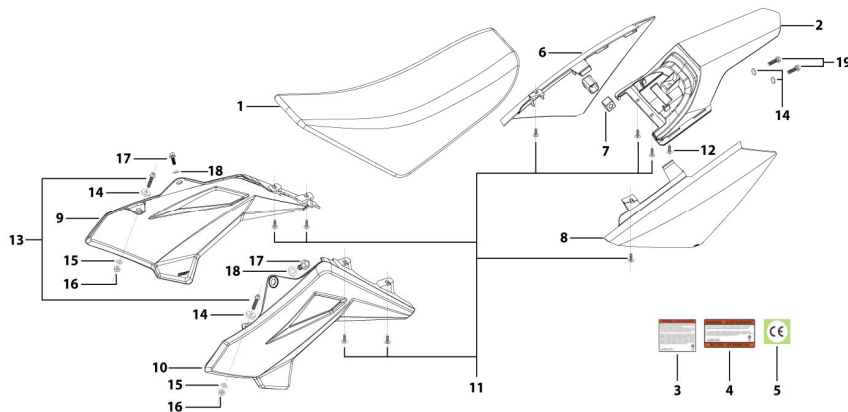

N°	Ref.	Description	Français	Picture	Qty/ Bike	MY
1	YC50-1401-05	YCF50 Seat assy L=425mm H=100mm 50A/50E 2012 Black	Selle YCF50L=425mm H=100mm 50A/50E 2012 Noir		1	
	YC50-1401-03	YCF50 Seat assy High L=425mm 2015	Selle haute YCF50 L=425mm 2015		1	AFTERMAR KET



BIKE CODE FOR ORDERS		26-50A-STD	BIKE DESCRIPTION NAME	YCF 50A 2026	CONTROL STATUS	
EFFECTED DATE(D/M/Y)		22/1/2026	VERSION	2026A0		
2	YC50-14-012-GY	YCF Rear fender 50CC GREY	Garde boue arrière YCF 50CC GRIS		1	
2	YC50-14-012-BK	YCF Rear fender 50CC BLACK	Garde boue arrière YCF 50CC NOIR		1	AFTERMAR KET
2	YC50-14-012-RD	YCF Rear fender 50CC RED	Garde boue arrière YCF 50CC ROUGE		1	AFTERMAR KET
2	YC50-14-012-PK	YCF Rear fender 50CC PINK	Garde boue arrière YCF 50CC ROSE		1	AFTERMAR KET
2	YC50-14-012-BL	YCF Rear fender 50CC BLUE	Garde boue arrière YCF 50CC BLEU		1	AFTERMAR KET
2	YC50-14-012-GR	YCF Rear fender 50CC GREEN	Garde boue arrière YCF 50CC VERT		1	AFTERMAR KET
2	YC50-14-012-YE	YCF Rear fender 50CC YELLOW	Garde boue arrière YCF 50CC JAUNE		1	AFTERMAR KET
2	YC50-14-012-OR	YCF Rear fender 50CC ORANGE	Garde boue arrière YCF 50CC ORANGE		1	AFTERMAR KET
2	YC50-14-012-WH	YCF50 Rear fender WHITE	Garde boue arrière YCF50 BLANC		1	AFTERMAR KET
6	YC50-14-022-GY	YCF right side plastic GREY 50CC	plaque latérale droite YCF 50CC Gris		1	
6	YC50-14-022-BK	YCF right side plastic BLACK 50CC	plaque latérale droite YCF 50CC NOIR		1	AFTERMAR KET
6	YC50-14-022-RD	YCF right side plasticRED 50CC	plaque latérale droite YCF 50CC ROUGE		1	AFTERMAR KET



BIKE CODE FOR ORDERS		26-50A-STD	BIKE DESCRIPTION NAME	YCF 50A 2026	CONTROL STATUS	
EFFECTED DATE(D/M/Y)		22/1/2026	VERSION	2026A0		
6	YC50-14-022-PK	YCF right side plastic PINK 50CC	plaque latérale droite YCF 50CC ROSE		1	AFTERMARKET
6	YC50-14-022-BL	YCF right side plastic BLUE 50CC	plaque latérale droite YCF 50CC BLEU		1	AFTERMARKET
6	YC50-14-022-GR	YCF right side plastic GREEN 50CC	plaque latérale droite YCF 50CC VERT		1	AFTERMARKET
6	YC50-14-022-YE	YCF right side plastic YELLOW 50CC	plaque latérale droite YCF 50CC JAUNE		1	AFTERMARKET
6	YC50-14-022-OR	YCF right side plastic ORANGE 50CC	plaque latérale droite YCF 50CC ORANGE		1	AFTERMARKET
6	YC50-14-022-WH	YCF right side plastic WHITE	Plaque latérale droite YCF BLANC		1	AFTERMARKET
7	YC110-14-03	Cushion for right side plastic Black	caoutchouc plaque laterale droite Noir		1	
8	YC50-14-042-GY	YCF Left side plastic Grey50CC	Plaque latérale gauche YCF 50CC Gris		1	
8	YC50-14-042-BK	YCF Left side plastic BLACK 50CC	Plaque latérale gauche YCF 50CC NOIR		1	AFTERMARKET
8	YC50-14-042-RD	YCF Left side plastic RED 50CC	Plaque latérale gauche YCF 50CC ROUGE		1	AFTERMARKET
8	YC50-14-042-PK	YCF Left side plastic PINK 50CC	Plaque latérale gauche YCF 50CC ROSE		1	AFTERMARKET
8	YC50-14-042-BL	YCF Left side plastic BLUE 50CC	Plaque latérale gauche YCF 50CC BLEU		1	AFTERMARKET
8	YC50-14-042-GR	YCF Left side plastic GREEN 50CC	Plaque latérale gauche YCF 50CC VERT		1	AFTERMARKET



BIKE CODE FOR ORDERS		26-50A-STD	BIKE DESCRIPTION NAME	YCF 50A 2026	CONTROL STATUS	
EFFECTED DATE(D/M/Y)		22/1/2026	VERSION	2026A0		
8	YC50-14-042-YE	YCF Left side plastic YELLOW 50CC	Plaque latérale gauche YCF 50CC JAUNE		1	AFTERMARKET
8	YC50-14-042-OR	YCF Left side plastic ORANGE 50CC	Plaque latérale gauche YCF 50CC ORANGE		1	AFTERMARKET
8	YC50-14-042-WH	YCF50 Left side plastic WHITE	Plaque latérale gauche YCF50 BLANCHE		1	AFTERMARKET
9	YC50-1407-GY	YCF Right GREY, 2025	Ouie radiateur droite YCF 50CC GRIS, 2025		1	
9	YC50-1407-YE	YCF Right YELLOW, 2025	Ouie radiateur droite YCF 50CC JAUNE, 2025		1	AFTERMARKET
9	YC50-1407-WH	YCF Right shroud WHITE 50CC, 2025	Ouie radiateur droite YCF 50CC BLANCHE, 2025		1	AFTERMARKET
9	YC50-1407-BK	YCF Right BLACK, 2025	Ouie radiateur droite YCF 50CC NOIR, 2025		1	AFTERMARKET
9	YC50-1407-RD	YCF Right RED, 2025	Ouie radiateur droite YCF 50CC ROUGE, 2025		1	AFTERMARKET
9	YC50-1407-PK	YCF Right PINK, 2025	Ouie radiateur droite YCF 50CC ROSE, 2025		1	AFTERMARKET
9	YC50-1407-BL	YCF Right BLUE, 2025	Ouie radiateur droite YCF 50CC BLEU, 2025		1	AFTERMARKET
9	YC50-1407-GR	YCF Right GREEN, 2025	Ouie radiateur droite YCF 50CC VERT, 2025		1	AFTERMARKET
9	YC50-1407-OR	YCF Right ORANGE, 2025	Ouie radiateur droite YCF 50CC ORANGE, 2025		1	AFTERMARKET
10	YC50-1406-GY	YCF Left side GREY 50CC, 2025	Ouie radiateur gauche YCF 50CC GRIS, 2025		1	



BIKE CODE FOR ORDERS		26-50A-STD	BIKE DESCRIPTION NAME	YCF 50A 2026	CONTROL STATUS	
EFFECTED DATE(D/M/Y)		22/1/2026	VERSION	2026A0		
10	YC50-1406-YE	YCF Left side YELLOW 50CC, 2025	Ouie radiateur gauche YCF 50CC JAUNE , 2025		1	AFTERMARKET
10	YC50-1406-WH	YCF Left side shroud WHITE 50CC, 2025	Ouie radiateur gauche YCF 50CC BLANCHE, 2025		1	AFTERMARKET
10	YC50-1406-BK	YCF Left side BLACK 50CC, 2025	Ouie radiateur gauche YCF 50CC NOIR, 2025		1	AFTERMARKET
10	YC50-1406-RD	YCF Left side RED 50CC, 2025	Ouie radiateur gauche YCF 50CC ROUGE , 2025		1	AFTERMARKET
10	YC50-1406-PK	YCF Left side PINK 50CC, 2025	Ouie radiateur gauche YCF 50CC ROSE , 2025		1	AFTERMARKET
10	YC50-1406-BL	YCF Left side BLUE 50CC, 2025	Ouie radiateur gauche YCF 50CC BLEU, 2025		1	AFTERMARKET
10	YC50-1406-GR	YCF Left side GREEN 50CC, 2025	Ouie radiateur gauche YCF 50CC VERT, 2025		1	AFTERMARKET
10	YC50-1406-OR	YCF Left side ORANGE 50CC, 2025	Ouie radiateur gauche YCF 50CC ORANGE , 2025		1	AFTERMARKET
11	GB845-ST4.8x16-G	Pan Head Cross Tapping Screw ST4.8x16mm	Vis taraudeuse à tête ronde cruciforme ST4.8x16mm		8	
12	GB845-ST4.8x20-G	Pan Head Cross Tapping Screw ST4.8x20mm	Vis taraudeuse à tête ronde cruciforme ST4.8x20mm		1	
13	BT08-M6x20-W	HEXAGON Torx screw with Flange M6x20mm	Vis HEXAGONALE Torx avec Flange M6x20mm		2	
14	YC110-03-01	Rubber washer d6mmxd18mmx4mm for seat fixation on subframe	joint caoutchouc d6mmxd18mmx4mm pour fixation selie sur boucle acier		4	
15	GB96-d6-W	Flat washer,steel d6mm	Rondelle plate,acier d6mm		2	
16	GB6177-M6-W	HEXAGON FLAT FLANGE NUT M6 steel	Ecrou HEXAGONAL avec Flange M6 acier		2	
17	FB5787-M5x12-W	hex.Bolt with flanged M5x12mm	Vis M5x12mm		2	
18	GB96-d5-W	Flat washer,steel d5mm	Rondelle plate,acier d5mm		2	



BIKE CODE FOR ORDERS		26-50A-STD	BIKE DESCRIPTION NAME	YCF 50A 2026	CONTROL STATUS	
EFFECTED DATE(D/M/Y)		22/1/2026	VERSION	2026A0		
19	BT08-M6x25-W	HEXAGON Torx screw with Flange M6x25mm	Vis HEXAGONALE Torx avec Flange M6x25mm		2	
19	KRV-BL	Aluminium rear spool BLUE	Diabolo aluminium BLEU		2	AFTERMARKET
19	KRV-BK	Aluminium rear spool BLACK	Diabolo aluminium NOIR		2	AFTERMARKET
19	KRV-RD	Aluminium rear spool RED	Diabolo aluminium ROUGE		2	AFTERMARKET
19	KRV-OR	Aluminium rear spool ORANGE	Diabolo aluminium ORANGE		2	AFTERMARKET
19	KRV-GR	Aluminium rear spool GREEN	Diabolo aluminium VERT		2	AFTERMARKET
19	KRV-PU	Aluminium rear spool PURPLE	Diabolo aluminium PURPLE		2	AFTERMARKET
	KVP3	PLASTIC SCREW KIT	KIT VIS PLASTIQUE - KVP3		2	AFTERMARKET
	KVP5	COMPLETE SCREW KIT	KIT VIS COMPLET - KVP5		2	AFTERMARKET

ELECTRIC

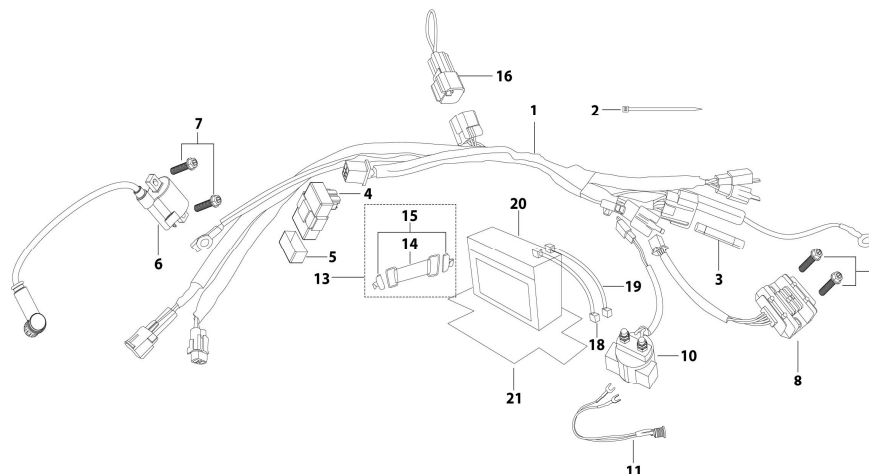



BIKE CODE FOR ORDERS		26-50A-STD	BIKE DESCRIPTION NAME	YCF 50A 2026	CONTROL STATUS	
EFFECTED DATE(D/M/Y)		22/1/2026	VERSION	2026A0		
N°	Ref.	Description	Français	Picture	Qty/ Bike	MY
1	YC50-1501-02	Wire harness 50CC 2020 waterproof L=570mm	Faisceaux électrique 50CC 2020 etanche L=570mm		1	
2	YC110-01-05-BK	Cable tie,nylon, L=350mm Black	colier maintien cable,nylon, L=350mm Noir		1	
3	YC50-1547-01	Fuse 50A d6mmx30mm F15AL250V	Fusible YCF50A d6mmx30mm F15AL250V		1	
4	YC50-1503	CDI Ignitor assy.50A	CDI 50A		1	
6	YC50-1504	Ignitor coil L=130mm	bobine haute tension L=130mm		1	
7	GB5787-M6x16-W	HEXAGON screw with Flange M6x16mm steel	Vis HEXAGONALE avec Flange M6x16mm acier		2	
8	YC50-1502	rectifier for 50CC	Rectificateur		1	
9	BT08-M6x10-W	HEXAGON Torx screw with Flange M6x10mm	Vis HEXAGONALE Torx avec Flange M6x10mm		2	
10	YC50-1510	relay 50CC	Relais demarreur 50CC		1	
11	YC50-1513-02	Charger connexion 50CC Comes with waterproof rubber plug	Connection chargeur 50CC Livré avec bouchon adhésif imperméable		1	
13	YC110-1508-03	Rubber band battery holder assy	Bande caoutchouc pour maintien batterie complete		1	
16	YC110-1563-01	Chunt waterproof	Chunte waterproof		1	
18	YC110-1517-03	Battery cable L=200mm RED 2020	Cable pour Chargeur Batterie L=200mm ROUGE 2020		1	
19	YC110-1516-05	Battery cable L=230mm Black 2020	Cable pour Chargeur Batterie L=230mm Noir 2020		1	







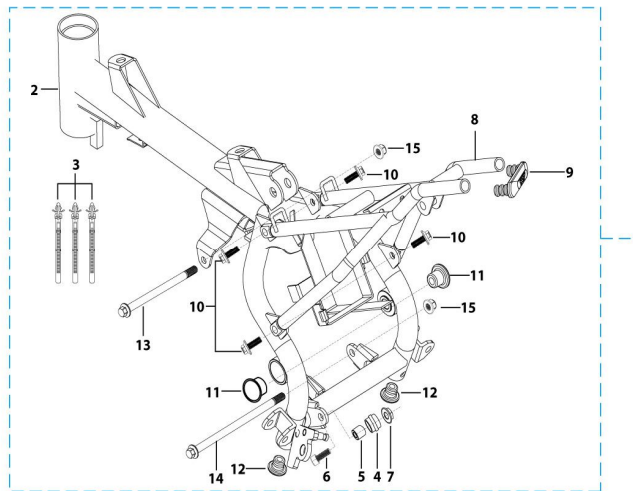



BIKE CODE FOR ORDERS		26-50A-STD	BIKE DESCRIPTION NAME	YCF 50A 2026	CONTROL STATUS	
EFFECTED DATE(D/M/Y)		22/1/2026	VERSION	2026A0		
20	YC110-1507-05	BS Battery BTx4L+ SLA 4.2Ah/12V/6.5A	BS Battery BTX4L+ SLA 4.2Ah/12V/6.5A		1	
21	YC110-1523-02	Battery protection 117mmx75mmx60mm	Protection Batterie 117mmx75mmx60mm		1	

Frame





N°	Ref.	Description	Français	Picture	Qty/ Bike	MY
1	YC50-1622-05-BK	Complète frame YCF50A 2026 Black (with YC50-1211 2EA) for KR DIRECTION46, STEERING STEM 24° ANGLE, Footpegs lower	Cadre complet YCF50A pour KR DIRECTION46, ANGLE POTENCE 24° 2026 Cales pieds abaisses Noir		1	
2	YC50-172-03-BK	Frame ONLY YCF50A 2026 BLACK (with YC50-1211 2EA) STEERING STEM 24° and the rear tailstock mounting plate is 5mm with a foot pedal lowered by 40mm ANGLE,	Cadre SEUL YCF50A 2026 ANGLE POTENCE 24° Plaque de montage arrière 5mm pied déplacé 40mm Cales pieds abaisses NOIR		1	
3	YC110-01-08-BK	Cable tie, PA66 L=80mm ADJUSTABLE Black	Collier maintien cable,PA66 L=80mm ADJUSTABLE Noir		3	
	YC50-2105	Side Wheels Kit. 50cc	Kit Stabilisateur 50cc		1	AFTERMARKET
4	YC50-2201	YCF Chain tensioner component (Middle 5.5mm)Black	roulette chaine YCF d35mmxd30mmx20mm(Milieu 5.5mm) Noir.		1	
5	FB13-10x14x10-W	bushing (Muffler Hoop spacer /chain tensioner) d10mmxd14mmx10mm	Entretoise attache silencieux /roulette de chaine d10mmxd14mmx10mm		1	
6	GB70-M10x50x1.5-W	HEXAGON SOCKET Head Bolt,steel, M10x50mmx1.5mm	Vis Allen (BTR),acier, M10x50mmx1.5mm		1	

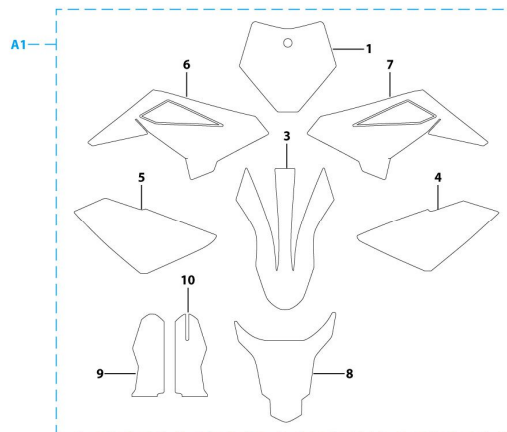

BIKE CODE FOR ORDERS		26-50A-STD	BIKE DESCRIPTION NAME	YCF 50A 2026	CONTROL STATUS	
EFFECTED DATE(D/M/Y)		22/1/2026	VERSION	2026A0		
7	GB6187-M10-1.5-W	HEXAGON FLAT FLANGE LOCK NUT M10-1.5	Ecrou HEXAGONAL avec Flange autobloquant M10-1.5		1	
8	YC50-16-04-BK	YCF50 Rear frame part chromoly 2020 Black FOR 125cc 12V/3A Battery and new fixation	Boucle arriere YCF50 chromoly 2020 NoirE pour Batterie 125cc 12V/3A et nouvelles fixations		1	
9	YC110-1633-0201	Rubber plug for SUBFRAME part START	Embout Caoutchouc YCF boucle arriere START		1	
10	BT08-M8x10-W	HEXAGON Torx screw with Flange M8x10mm	Vis HEXAGONALE Torx avec Flange M8x10mm		4	
11	YC50-1210	Rubber cover (swing arm axle)	Capuchon cadre (axe bras)		2	
12	YC50-1211	Rubber cover (bottom of frame) 50CC Black	Capuchon cadre (dessous cadre) 50CC NOIR		2	
13	BT08-M8x95-B-W	HEXAGON Torx screw with Flange M8x95mm half thread	Vis HEXAGONALE Torx avec Flange M8x95mm VIS FILETAGE PARTIEL		1	
14	BT08-M8x100-B-W	HEXAGON Torx screw with Flange M8x100mm half thread	Vis HEXAGONALE Torx avec Flange M8x100mm VIS FILETAGE PARTIEL		1	
15	GB6183-M8-Cr	Flanged nylon lock nut M8 Blue nylon chrome plated	Nylon de verrouillage en flange M8 Nylon Bleu Nylon		2	

GRAPHICS



N°	Ref.	Description	Français	Picture	Qty/ Bike	MY
A1	KD50AE2026	YCF50A complete graphic kit 2026	Kit deco complet YCF50A 2026		1	



YCF-Riding.com



2026

BIKE CODE FOR ORDERS		26-50A-STD	BIKE DESCRIPTION NAME	YCF 50A 2026	CONTROL STATUS	
EFFECTED DATE(D/M/Y)		22/1/2026	VERSION	2026A0		
STSVYCF-01	YCF STICKER SHEET A4 VARIOUS	PLANCHE STICKERS A4 YCF DIVERS			1	AFTERMARKET

ENGINES

N°	Ref.	Description	Français	Picture	Qty/ Bike	Rep. Pst.
1	MOTEUR50-02-GY	Engine 50cc 2020	Moteur 50cc 2020		1	
2	17311-10	Inlet Pipe,Pro 50cc 2021	PIPE ADMISSION 50cc 2021		1	
3	BT08-M6x20-W	HEXAGON Torx screw with Flange M6x20mm	Vis HEXAGONALE Torx avec Flange M6x20mm		2	
4	YC50-20-29	carburettor paper gasket	joint papier carburateur		1	
5	YC50-20-25	intake pipe paper gasket	joint papier admission		1	
6	YC50-20-26	intake pipe isolating gasket	joint plastique admission		1	
7	YC50-20-97	Front Sprocket plastic cover	Protection plastique PSB		1	
8	GB5787-M5x25-W	HEXAGON screw with Flange M5x25mm steel	Vis HEXAGONALE avec Flange M5x25mm acier		3	
9	420H/9T	Sprocket (9T)	PSB 9DTS		1	
9	420H/10T	Sprocket(10T)	PSB 10 DTS		1	AFTERMARKET
	JH02-SI	CNC dipstick YCF 50A SILVER	JAUGE HUILE PETIT MODELE 50A SILVER		1	AFTERMARKET
	TREPIED02-BK	steel stand H=320mm BLACK	TREPIED ACIER NOIR POUR 50/88 320m		1	AFTERMARKET



BIKE CODE FOR ORDERS		26-50A-STD	BIKE DESCRIPTION NAME	YCF 50A 2026	CONTROL STATUS	
EFFECTED DATE(D/M/Y)		22/1/2026	VERSION	2026A0		
TREPIED01-BK	Steel Stand H=400mm BLACK	Trepied Acier H=400mm NOIR		1	AFTERMARKET	
TREPIED-BK	Aluminium Stand H=400mm Black	Trepied Aluminium H=400mm Noir		1	AFTERMARKET	
TREPIED-BL	Aluminium Stand H=400mm Blue	Trepied Aluminium H=400mm Bleu		1	AFTERMARKET	
TREPIED-GR	Aluminium Stand H=400mm Green	Trepied Aluminium H=400mm Vert		1	AFTERMARKET	
TREPIED-OR	Aluminium Stand H=400mm Orange	Trepied Aluminium H=400mm Orange		1	AFTERMARKET	
TREPIED-RD	Aluminium Stand H=400mm Red	Trepied Aluminium H=400mm Rouge		1	AFTERMARKET	
CHAIR01-BK	Folding-chair YCF Black	Chaise pliable YCF Noir		1	AFTERMARKET	
BIKECOVER-BL	YCF Motorcycle Cover BLUE	Bache Moto YCF BLEU		1	AFTERMARKET	
UMBRELLA	Umbrella YCF 2015	Parapluie YCF BLEU		1	AFTERMARKET	
TONNELLEYCF-4	YCF Gazebo 3 x 3 2021 BLUE	TONELLES YCF 3x3 2021 avec toit BLEU - BLANCHE		1	AFTERMARKET	
PORTE-1	Door for YCF Gazebo	COTE GAZEBO AVEC PORTE GRISE		1	AFTERMARKET	
COTE-1-BL	Side wall for Gazebo BLUE	COTE DE TONNELLE 3x3M BLEU		1	AFTERMARKET	















BIKE CODE FOR ORDERS	26-50A-STD	BIKE DESCRIPTION NAME	YCF 50A 2026	CONTROL STATUS	
EFFECTED DATE(D/M/Y)	22/1/2026	VERSION	2026A0		
DEMICOTE-1	Half side wall for Gazebo	DEMI COTE POUR GAZEBO GRIS		1	AFTERMARKET
OUTIL	Unsettle tool	OUTIL POUR DEMONTER EMBRAYAGE		1	AFTERMARKET
ARRACHE	Flywheel puller	ARRACHE VOLANT MAGNETIQUE		1	AFTERMARKET
ARRACHE-1	Flywheel puller All-purpose	ARRACHE VOLANT MAGNETIQUE		1	AFTERMARKET
CLEARAYON-02	SPOKE TOOL	CLE A RAYON YCF		1	AFTERMARKET
CDP	Tyre pressure gauge	CONTROLEUR PRESSION PNEU		1	AFTERMARKET
CB	Spark plug socket	CLE A BOUGIE		1	AFTERMARKET
FF271	Thread locker Red	FREIN A FILET ROUGE		1	AFTERMARKET
FF242	thread locker Blue	FREIN A FILET BLEU		1	AFTERMARKET
JCM-1	Feeler gauge (0.1-1mm)	Jeu de cale moteur (0.1-1mm)		1	AFTERMARKET
DERIVE-1	Chain rivet tool	Derive chaine		1	AFTERMARKET
DEMONT-1	Tire Iron	Demonte pneu		1	AFTERMARKET















BIKE CODE FOR ORDERS		26-50A-STD	BIKE DESCRIPTION NAME	YCF 50A 2026	CONTROL STATUS	
EFFECTED DATE(D/M/Y)		22/1/2026	VERSION	2026A0		
YC110-2410-01	VALVE ADJUSTMET TOOL/WRENCH	Outils motos de soupapes démontage		1	AFTERMARKET	
TSK02BL-4	T-shirt kids 4years 2019 BLUE	T-shirt enfant 4 ans 2019 BLEU		1	AFTERMARKET	
TSK02BL-8	T-shirt kids 8years 2019 BLUE	T-shirt enfant 8ans 2019 BLEU		1	AFTERMARKET	
BACKPACKYCF-GY	YCF BACKPACK Dimensions : 44cmx29cmx14cm	SAC A DOS YCF Dimensions : 44cmx29cmx14cm		1	AFTERMARKET	
BAGYCF-BL	BAG Dimensions: 54cmx32cmx32cm	SAC DE TRANSPORT Dimensions: 54cmx32cmx32cm		1	AFTERMARKET	
POLOYCF01BL-S	YCF RACING POLO BLUE 2022 S	POLO YCF BLEU 2022 S		1	AFTERMARKET	
POLOYCF01BL-M	YCF RACING POLO BLUE 2022 M	POLO YCF BLEU 2022 M		1	AFTERMARKET	
POLOYCF01BL-L	YCF RACING POLO BLUE 2022 L	POLO YCF BLEU 2022 L		1	AFTERMARKET	
POLOYCF01BL-XL	YCF RACING POLO BLUE 2022 XL	POLO YCF BLEU 2022 XL		1	AFTERMARKET	
POLOYCF01BL-XXL	YCF RACING POLO BLUE 2022 XXL	POLO YCF BLEU 2022 XXL		1	AFTERMARKET	
SWEAT05BL-S	YCF SWEAT SHIRT BLUE 2026 S	SWEAT SHIRT YCF BLEU 2026 S		1	AFTERMARKET	
SWEAT05BL-M	YCF SWEAT SHIRT BLUE 2026 M	SWEAT SHIRT YCF BLEU 2026 M		1	AFTERMARKET	















BIKE CODE FOR ORDERS		26-50A-STD	BIKE DESCRIPTION NAME	YCF 50A 2026	CONTROL STATUS	
EFFECTED DATE(D/M/Y)		22/1/2026	VERSION	2026A0		
SWEAT05BL-L	YCF SWEAT SHIRT BLUE 2026 L	SWEAT SHIRT YCF BLEU 2026 L		1	AFTERMARKET	
SWEAT05BL-XL	YCF SWEAT SHIRT BLUE 2026 XL	SWEAT SHIRT YCF BLEU 2026 XL		1	AFTERMARKET	
SWEAT05BL-XXL	YCF SWEAT SHIRT BLUE 2026 XXL	SWEAT SHIRT YCF BLEU 2026 XXL		1	AFTERMARKET	
TSYCFGY03-S	YCF T SHIRT GREY 2026 S	T-SHIRT YCF GRIS 2026 S		1	AFTERMARKET	
TSYCFGY03-M	YCF T SHIRT GREY 2026 M	T-SHIRT YCF GRIS 2026 M		1	AFTERMARKET	
TSYCFGY03-L	YCF T SHIRT GREY 2026 L	T-SHIRT YCF GRIS 2026 L		1	AFTERMARKET	
TSYCFGY03-XL	YCF T SHIRT GREY 2026 XL	T-SHIRT YCF GRIS 2026 XL		1	AFTERMARKET	
TSYCFGY03-XXL	YCF T SHIRT GREY 2026 XXL	T-SHIRT YCF GRIS 2026 XXL		1	AFTERMARKET	
TSFYCFGY03-XS	YCF T SHIRT FEMALE GREY 2026 XS	T-SHIRT FEMME YCF GRIS 2026 XS		1	AFTERMARKET	
TSFYCFGY03-S	YCF T SHIRT FEMALE GREY 2026 S	T-SHIRT FEMME YCF GRIS 2026 S		1	AFTERMARKET	
TSFYCFGY03-M	YCF T SHIRT FEMALE GREY 2026 M	T-SHIRT FEMME YCF GRIS 2026 M		1	AFTERMARKET	
TSYCFWH03-S	YCF T SHIRT WHITE 2026 S	T-SHIRT YCF BLANC 2026 S		1	AFTERMARKET	















BIKE CODE FOR ORDERS		26-50A-STD	BIKE DESCRIPTION NAME	YCF 50A 2026	CONTROL STATUS	
EFFECTED DATE(D/M/Y)		22/1/2026	VERSION	2026A0		
TSYCFWH03-M	YCF T SHIRT WHITE 2026 M	T-SHIRT YCF BLANC 2026 M		1	AFTERMAR KET	
TSYCFWH03-L	YCF T SHIRT WHITE 2026 L	T-SHIRT YCF BLANC 2026 L		1	AFTERMAR KET	
TSYCFWH03-XL	YCF T SHIRT WHITE 2026 XL	T-SHIRT YCF BLANC 2026 XL		1	AFTERMAR KET	
TSYCFWH03-XXL	YCF T SHIRT WHITE 2026 XXL	T-SHIRT YCF BLANC 2026 XXL		1	AFTERMAR KET	
TSFYCFWH02-XS	YCF T SHIRT FEMALE WHITE 2026 XS	T-SHIRT FEMME YCF BLANC 2026 XS		1	AFTERMAR KET	
TSFYCFWH02-S	YCF T SHIRT FEMALE WHITE 2026 S	T-SHIRT FEMME YCF BLANC 2026 S		1	AFTERMAR KET	
TSFYCFWH02-M	YCF T SHIRT FEMALE WHITE 2026 M	T-SHIRT FEMME YCF BLANC 2026 M		1	AFTERMAR KET	
TSYCFYE03-S	YCF T SHIRT YELLOW 2026 S	T-SHIRT YCF JAUNE 2026 S		1	AFTERMAR KET	
TSYCFYE03-M	YCF T SHIRT YELLOW 2026 M	T-SHIRT YCF JAUNE 2026 M		1	AFTERMAR KET	
TSYCFYE03-L	YCF T SHIRT YELLOW 2026 L	T-SHIRT YCF JAUNE 2026 L		1	AFTERMAR KET	
TSYCFYE03-XL	YCF T SHIRT YELLOW 2026 XL	T-SHIRT YCF JAUNE 2026 XL		1	AFTERMAR KET	
TSYCFYE03-XXL	YCF T SHIRT YELLOW 2026 XXL	T-SHIRT YCF JAUNE 2026 XXL		1	AFTERMAR KET	



BIKE CODE FOR ORDERS		26-50A-STD	BIKE DESCRIPTION NAME	YCF 50A 2026	CONTROL STATUS	
EFFECTED DATE(D/M/Y)		22/1/2026	VERSION	2026A0		
TSFYCFYE02-XS	YCF T SHIRT FEMALE YELLOW 2026 XS	T-SHIRT FEMME YCF JAUNE 2026 XS		1	AFTERMAR KET	
TSFYCFYE02-S	YCF T SHIRT FEMALE YELLOW 2026 S	T-SHIRT FEMME YCF JAUNE 2026 S		1	AFTERMAR KET	
TSFYCFYE02-M	YCF T SHIRT FEMALE YELLOW 2026 M	T-SHIRT FEMME YCF JAUNE 2026 M		1	AFTERMAR KET	
TSYCFBL03-S	YCF T SHIRT BLUE 2026 S	T-SHIRT YCF BLEU 2026 S		1	AFTERMAR KET	
TSYCFBL03-M	YCF T SHIRT BLUE 2026 M	T-SHIRT YCF BLEU 2026 M		1	AFTERMAR KET	
TSYCFBL03-L	YCF T SHIRT BLUE 2026 L	T-SHIRT YCF BLEU 2026 L		1	AFTERMAR KET	
TSYCFBL03-XL	YCF T SHIRT BLUE 2026 XL	T-SHIRT YCF BLEU 2026 XL		1	AFTERMAR KET	
TSYCFBL03-XXL	YCF T SHIRT BLUE 2026 XXL	T-SHIRT YCF BLEU 2026 XXL		1	AFTERMAR KET	
TSFYCFBL02-XS	YCF T SHIRT FEMALE BLUE 2026 XS	T-SHIRT FEMME YCF BLEU 2026 XS		1	AFTERMAR KET	
TSFYCFBL02-S	YCF T SHIRT FEMALE BLUE 2026 S	T-SHIRT FEMME YCF BLEU 2026 S		1	AFTERMAR KET	
TSFYCFBL02-M	YCF T SHIRT FEMALE BLUE 2026 M	T-SHIRT FEMME YCF BLEU 2026 M		1	AFTERMAR KET	
TSYCFRD03-S	YCF T SHIRT RED 2026 S	T-SHIRT YCF ROUGE 2026 S		1	AFTERMAR KET	



BIKE CODE FOR ORDERS		26-50A-STD	BIKE DESCRIPTION NAME	YCF 50A 2026	CONTROL STATUS	
EFFECTED DATE(D/M/Y)		22/1/2026	VERSION	2026A0		
TSYCFRD03-M	YCF T SHIRT RED 2026 M	T-SHIRT YCF ROUGE 2026 M		1	AFTERMAR KET	
TSYCFRD03-L	YCF T SHIRT RED 2026 L	T-SHIRT YCF ROUGE 2026 L		1	AFTERMAR KET	
TSYCFRD03-XL	YCF T SHIRT RED 2026 XL	T-SHIRT YCF ROUGE 2026 XL		1	AFTERMAR KET	
TSYCFRD03-XXL	YCF T SHIRT RED 2026 XXL	T-SHIRT YCF ROUGE 2026 XXL		1	AFTERMAR KET	
TSFYCFRD02-XS	YCF T SHIRT FEMALE RED 2026 XS	T-SHIRT FEMME YCF ROUGE 2026 XS		1	AFTERMAR KET	
TSFYCFRD02-S	YCF T SHIRT FEMALE RED 2026 S	T-SHIRT FEMME YCF ROUGE 2026 S		1	AFTERMAR KET	
TSFYCFRD02-M	YCF T SHIRT FEMALE RED 2026 M	T-SHIRT FEMME YCF ROUGE 2026 M		1	AFTERMAR KET	
TSYCFGR03-S	YCF T SHIRT GREEN 2026 S	T-SHIRT YCF VERT 2026 S		1	AFTERMAR KET	
TSYCFGR03-M	YCF T SHIRT GREEN 2026 M	T-SHIRT YCF VERT 2026 M		1	AFTERMAR KET	
TSYCFGR03-L	YCF T SHIRT GREEN 2026 L	T-SHIRT YCF VERT 2026 L		1	AFTERMAR KET	
TSYCFGR03-XL	YCF T SHIRT GREEN 2026 XL	T-SHIRT YCF VERT 2026 XL		1	AFTERMAR KET	
TSYCFGR03-XXL	YCF T SHIRT GREEN 2026 XXL	T-SHIRT YCF VERT 2026 XXL		1	AFTERMAR KET	



BIKE CODE FOR ORDERS	26-50A-STD	BIKE DESCRIPTION NAME	YCF 50A 2026	CONTROL STATUS	
EFFECTED DATE(D/M/Y)	22/1/2026	VERSION	2026A0		
TSFYCFGR02-XS	YCF T SHIRT FEMALE GREEN 2026 XS	T-SHIRT FEMME YCF VERT 2026 XS		1	AFTERMARKET
TSFYCFGR02-S	YCF T SHIRT FEMALE GREEN 2026 S	T-SHIRT FEMME YCF VERT 2026 S		1	AFTERMARKET
TSFYCFGR02-M	YCF T SHIRT FEMALE GREEN 2026 M	T-SHIRT FEMME YCF VERT 2026 M		1	AFTERMARKET
BYCF01-BK	YCF woolen hat 2019 BLACK	Bonnet YCF 2019 NOIR		1	AFTERMARKET
BOB-BK	YCF Track hat with logo Black	Bob YCF avec logo Noir		1	AFTERMARKET
STHYCF	YCF STRAW HAT	CHAPEAU YCF		1	AFTERMARKET
CYCF06-GY	2026 CURVED BILL HAT	CASQUETTE YCF À VISIÈRE COURBÉE 2026		1	AFTERMARKET
CYCF06-PU	2026 SNAPBACK HAT CAP	CASQUETTE BASEBALL YCF 2026		1	AFTERMARKET
CYCF06-WH	2026 CURVED BILL HAT	CASQUETTE YCF À VISIÈRE COURBÉE 2026		1	AFTERMARKET
CYCF06-YE	2026 SNAPBACK HAT CAP	CASQUETTE BASEBALL YCF 2026		1	AFTERMARKET
CYCF06-BL	2026 SNAPBACK HAT CAP	CASQUETTE BASEBALL YCF 2026		1	AFTERMARKET
CYCF06-RD	2026 SNAPBACK HAT CAP	CASQUETTE BASEBALL YCF 2026		1	AFTERMARKET



BIKE CODE FOR ORDERS		26-50A-STD	BIKE DESCRIPTION NAME	YCF 50A 2026	CONTROL STATUS	
EFFECTED DATE(D/M/Y)		22/1/2026	VERSION	2026A0		
CYCF06-GR	2026 SNAPBACK HAT CAP	CASQUETTE BASEBALL YCF 2026		1	AFTERMAR KET	
BANNER-01	YCF Banner 2000x800mm BLACK	Banderolle tissu YCF 2000x800mm NOIR		1	AFTERMAR KET	
TAPISSOL-4	YCF CARPET 180x80cm	TAPIS YCF 180x80cm		1	AFTERMAR KET	

